

| REVISIONS | | | |
|-----------|-----------------|------------|-----------|
| REV. | DESCRIPTION | DATE | APPROVED |
| A | INITIAL RELEASE | 05/23/2019 | BPUCHASKI |

L-com
 PN: LCAT1003-20
 Date Code: YYWW

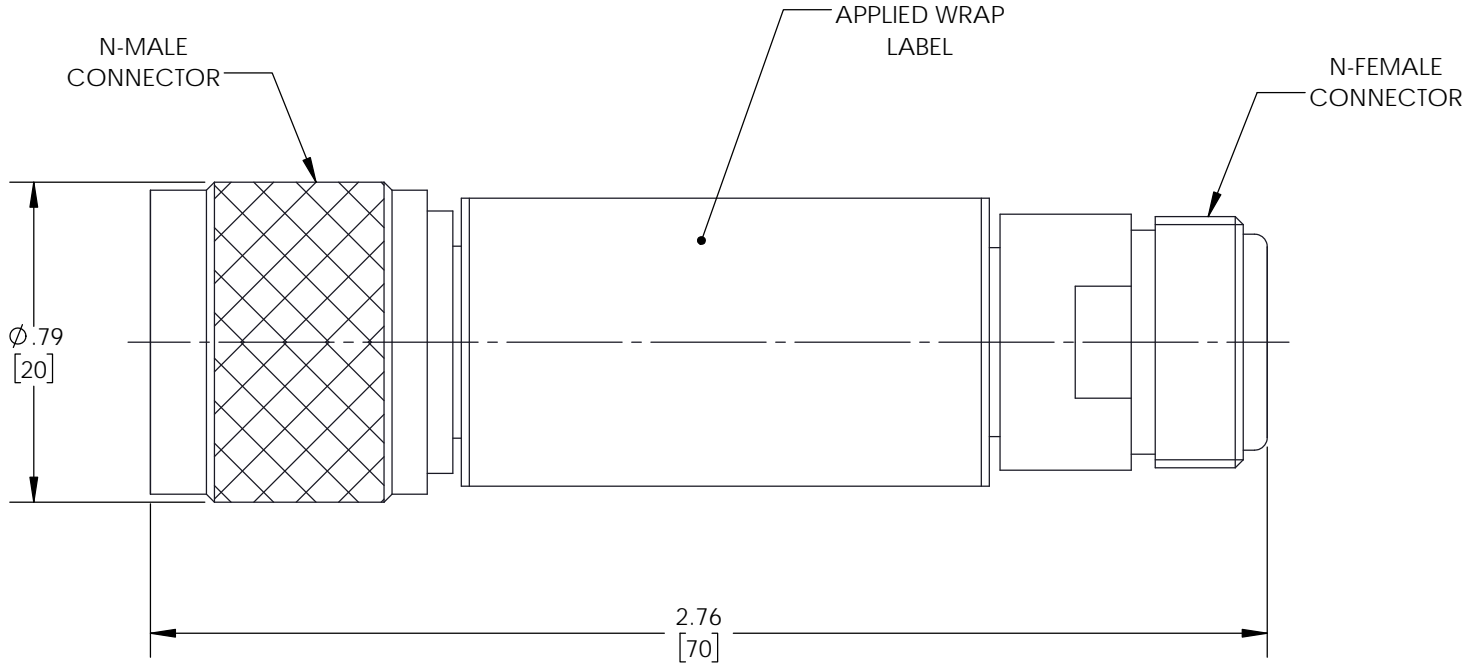

| | |
|--|------------------|
| UNLESS OTHERWISE SPECIFIED LEADING DIMENSIONS ARE INCHES DIMENSIONS IN [] ARE MILLIMETERS | |
| TOLERANCES: | |
| X±.2 [5.08] | FRACTIONS ± 1/32 |
| .XX±.01 [.25] | ANGLES ± 1° |
| .XXX±.005 [.13] | |
| ALL DIMENSIONS SHOWN ARE FOR REFERENCE ONLY. | |
| THIRD-ANGLE PROJECTION | |
| | |

L-com
 an INFINITO brand
 50 High Street, West Mill, 3rd Floor, Suite #30
 North Andover, MA 01845 USA.
 Phone: 1.800.341.5266 | 1.978.682.6936
 Fax: 1.978.689.9484
 www.L-com.com | e-mail: CustomerService@L-com.com

| | | | | |
|------|-------|-----------|-------------|-----|
| SIZE | CAGE | DRAWN BY | PART NUMBER | REV |
| A | 43321 | BPUCHASKI | LCAT1003-20 | A |

THE INFORMATION AND DESIGN IN THIS DOCUMENT IS THE PROPERTY OF L-COM GLOBAL CONNECTIVITY. ALL RIGHTS RESERVED.

SHEET 1 OF 1

SCALE N/A

THESE COMMODITIES, TECHNOLOGY OR SOFTWARE WERE EXPORTED FROM THE UNITED STATES IN ACCORDANCE WITH THE EXPORT ADMINISTRATION REGULATIONS. DIVERSION CONTRARY TO U.S. LAW PROHIBITED.