

24 dB Fixed Attenuator SMA Male to SMA Female Up to 18 GHz Rated to 2 Watts with Passivated Stainless Steel Body

Fairview Microwave carries a broad selection of fixed attenuators with a wide range of attenuation levels, frequency ranges, and power dissipation ranges. Also known as RF pads, RF microwave attenuators lower the amplitude of a signal (or attenuate) a known amount. These attenuator pads can be used in a wide variety of applications including reducing a signal level to protect measurement equipment or other circuitry, extending the range of power meters and amplifiers, and impedance matching circuits by reducing the VSWR seen by adjacent components. RF attenuators can prevent signal overload in amplifiers, receivers and detectors, adjusting the signal level to a range that is optimal.

Few RF components are as commonly used as fixed coaxial attenuators, and Fairview Microwave carries one of the largest in-stock varieties and ships them same day. The SA18E-24 is a 24 dB Fixed Attenuator that operates from DC to 18 GHz and is rated to 2 Watts. The versatile coaxial package uses SMA male to SMA female connectors and is also REACH and RoHS compliant.

Electrical Specifications

Description	Min	Typ	Max	Units
Frequency Range	DC		18	GHz
Impedance		50		Ohms
Nominal Attenuation		24		dB
Attenuation Accuracy		±1.25		dB
VSWR			1.35:1	
Input Power, CW derated linearly to 0.2W at +125°C			2	Watts
Input Power, Peak 5µs pulse, 0.1% duty cycle			500	Watts

Mechanical Specifications

Size	
Length	1.02 in [25.91 mm]
Width/Diameter	0.312 in [7.92 mm]
Weight	0.0155 lbs [7.03 g]
Body Material and Plating	Passivated Stainless Steel

Configuration

Design	Fixed
Package Style	Connectorized Module



Features:

- DC to 18 GHz Frequency Range
- Attenuation 24±1.25 dB
- Max Power 2 Watts (CW)
- VSWR < 1.35:1

Applications:

- Instrumentation
- Precision measurements
- Prototyping and characterization
- Production systems

Fairview Microwave
 301 Leora Ln., Suite 100
 Lewisville, TX 75056
 Tel: 1-800-715-4396 / (972) 649-6678
 Fax: (972) 649-6689
www.fairviewmicrowave.com
sales@fairviewmicrowave.com

Connectors

Description	Connector 1	Connector 2
Type	SMA Male	SMA Female
Connector Spec.	MIL-STD-348	MIL-STD-348
Contact Material & Plating	Beryllium Copper, Gold	Beryllium Copper, Gold
Body Material & Plating	Passivated Stainless Steel	Passivated Stainless Steel

Mechanical Specification Notes:
Connector interface in accordance with MIL-STD-348 and MIL-PRF-39012.
Materials and finishes comply with MIL-DTL-3933.

Environmental Specifications

Temperature

Operating Range -65 to +125 deg C

Environmental Specification Notes:
Designed to meet environmental requirements of MIL-DTL-3933.

Compliance Certifications (see [product page](#) for current document)

Plotted and Other Data

Notes:

24 dB Fixed Attenuator SMA Male to SMA Female Up to 18 GHz Rated to 2 Watts with Passivated Stainless Steel Body from Fairview Microwave is in-stock and available to ship same-day. All of our RF/microwave products are available off-the-shelf from our ISO 9001:2008 certified facilities in Allen, Texas. Fairview Microwave is RF on-demand.

For additional information on this product, please click the following link: [24 dB Fixed Attenuator SMA Male to SMA Female Up to 18 GHz Rated to 2 Watts with Passivated Stainless Steel Body SA18E-24](#)

URL: <https://www.fairviewmicrowave.com/24db-fixed-attenuator-sma-male-sma-female-2-watts-sa18e-24-p.aspx>

The information contained in this document is accurate to the best of our knowledge and representative of the part described herein. It may be necessary to make modifications to the part and/or the documentation of the part, in order to implement improvements. Fairview Microwave reserves the right to make such changes as required. Unless otherwise stated, all specifications are nominal. Fairview Microwave does not make any representation or warranty regarding the suitability of the part described herein for any particular purpose, and Fairview Microwave does not assume any liability arising out of the use of any part or documentation.

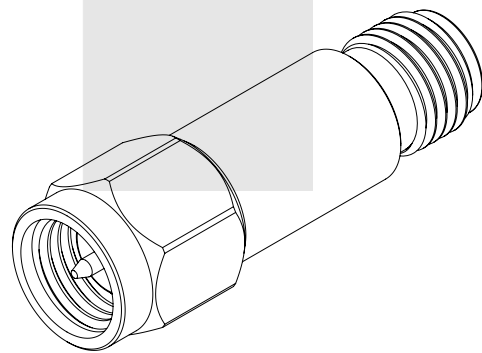
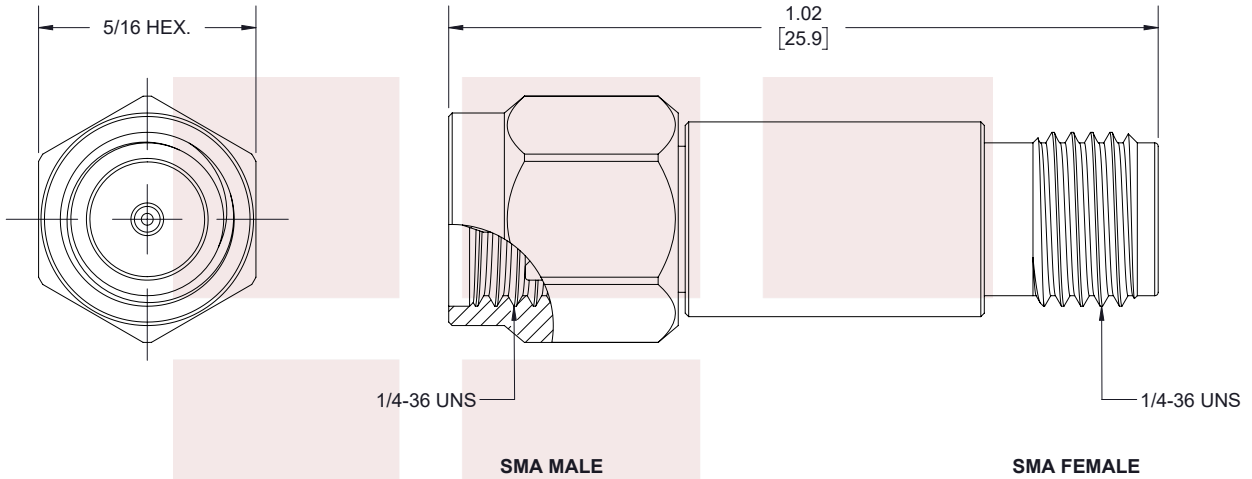

LABEL

Fairview Microwave
RF COMPONENTS ON DEMAND. *Done!*
www.FAIRVIEWMICROWAVE.com
SA18E-24
YYWW

STANDARD TOLERANCES

.X ±0.2
.XX ±0.01
.XXX ±0.005

*STANDARD TOLERANCES APPLY ONLY TO DIMENSIONS IN INCHES

NOTES:
1. UNLESS OTHERWISE SPECIFIED ALL DIMENSIONS ARE NOMINAL.
2. ALL SPECIFICATIONS ARE SUBJECT TO CHANGE WITHOUT NOTICE AT ANY TIME.
3. DIMENSIONS ARE IN INCHES [mm].

TITLE
24 dB Fixed Attenuator SMA Male to SMA Female Up to 18 GHz Rated to 2 Watts with Passivated Stainless Steel Body

DWG NO	SA18E-24		CAGE CODE	3FKR5		
CAD FILE	12/18/18	SHEET	1 OF 1	SCALE	N/A	SIZE A 7361