

0 to 90 dB Step Attenuator 50 Ohm BNC Female To 50 Ohm BNC Female With 1 dB Step Rated To 2 Watts Up To 1 GHz in a Push Button design

The FMAT1040B is a Step Attenuator that has 90 dB of total attenuation with 1, 2, 4, 8, 16, 20, 20, and 20 dB push button steps, designed across the frequency range of DC to 1 GHz. Select button for desired attenuation level, total attenuation is the sum of all buttons selected. The design is tried and true technology that offers exceptional performance characteristics that include 2 dB maximum insertion loss, and a maximum VSWR of 1.4:1. The design also features excellent attenuation accuracy with 3% Maximum. The Nickel plated Brass package has BNC Female connectors, and operates within the temperature range of -20°C to 85°C.

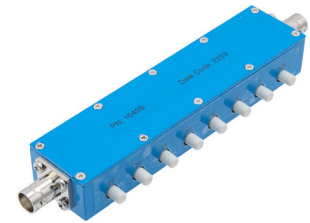

Electrical Specifications

Description	Min	Typ	Max	Units
Frequency Range	DC		1,000	MHz
Impedance		50		Ohms
Insertion Loss			2	dB
Attenuation Value		0 to 90		dB
Step Size		1		dB
Step Type		Push Button		
Accuracy Statement	±0.8dB (<50dB Atten)		±3%dB (>50dB Atten)	
Input Power (CW)			2	Watts
Input Power, Peak 5 μs pulse width 2% duty cycle			100	Watts
VSWR			1.4:1	

Mechanical Specifications

Size	
Length	6.142 in [156.01 mm]
Width	0.787 in [19.99 mm]
Height	1.398 in [35.51 mm]
Weight	0.375 lbs [170.1 g]
Body Material and Plating	Aluminum, Paint

Connectors

Description	Connector 1	Connector 2
Type	BNC Female	BNC Female
Contact Material & Plating	Beryllium Copper, Gold	Beryllium Copper, Gold
Body Material & Plating	Brass, Nickel	Brass, Nickel

Environmental Specifications

Temperature	
Operating Range	-20 to 85 deg C

Features:

- 1, 2, 4, 8, 16, 20, 20, and 20 dB step buttons
- 0 to 90 dB Attenuation
- 3% Attenuation Accuracy Maximum
- BNC Female Connectors
- Maximum Power 2 Watts (CW)

Applications:

- Instrumentation
- Precision Measurements
- Prototyping and Characterization
- Production Systems

Fairview Microwave
301 Leora Ln., Suite 100
Lewisville, TX 75056
Tel: 1-800-715-4396 / (972) 649-6678
Fax: (972) 649-6689
www.fairviewmicrowave.com
sales@fairviewmicrowave.com

Compliance Certifications (see [product page](#) for current document)

Plotted and Other Data

Notes:

0 to 90 dB Step Attenuator 50 Ohm BNC Female To 50 Ohm BNC Female With 1 dB Step Rated To 2 Watts Up To 1 GHz in a Push Button design from Fairview Microwave is in-stock and available to ship same-day. All of our RF/microwave products are available off-the-shelf from our ISO 9001:2008 certified facilities in Lewisville, Texas. Fairview Microwave is RF on-demand.

For additional information on this product, please click the following link: [0 to 90 dB Step Attenuator 50 Ohm BNC Female To 50 Ohm BNC Female With 1 dB Step Rated To 2 Watts Up To 1 GHz in a Push Button design FMAT1040B](#)

URL: <https://www.fairviewmicrowave.com/90db-step-attenuator-1db-bnc-female-dc-1-ghz-2-watts-fmat1040b-p.aspx>

The information contained in this document is accurate to the best of our knowledge and representative of the part described herein. It may be necessary to make modifications to the part and/or the documentation of the part, in order to implement improvements. Fairview Microwave reserves the right to make such changes as required. Unless otherwise stated, all specifications are nominal. Fairview Microwave does not make any representation or warranty regarding the suitability of the part described herein for any particular purpose, and Fairview Microwave does not assume any liability arising out of the use of any part or documentation.

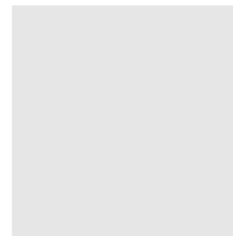
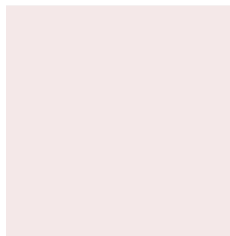
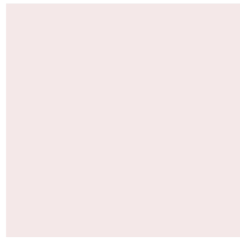
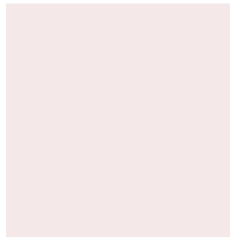

REVISIONS			
REV.	DESCRIPTION	DATE	APPROVED
A	INITIAL RELEASE	12/28/22	SPONG

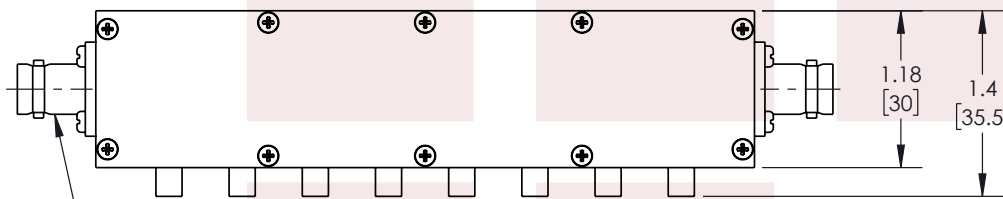
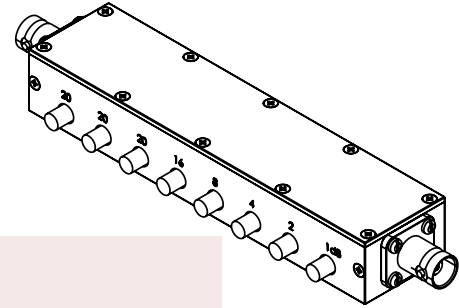

2X BNC FEMALE CONNECTOR

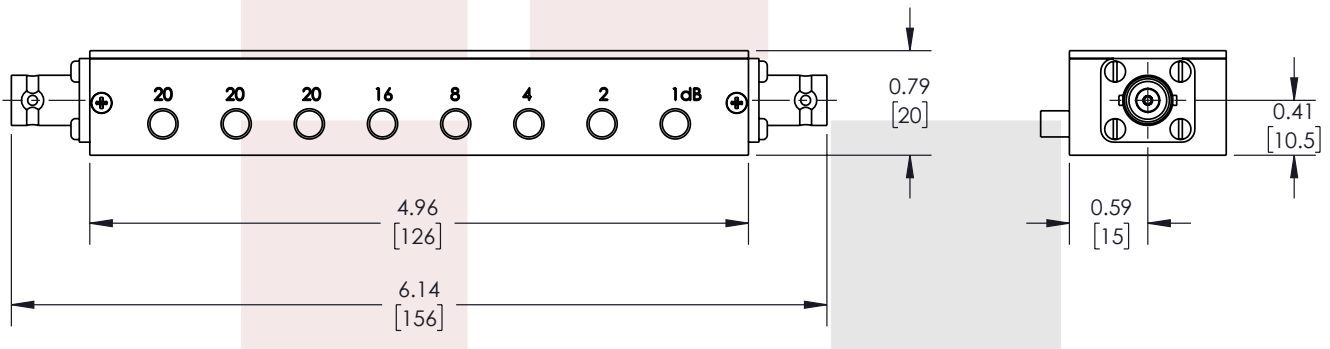

THESE COMMODITIES, TECHNOLOGY OR SOFTWARE WERE EXPORTED FROM THE UNITED STATES IN ACCORDANCE WITH THE EXPORT ADMINISTRATION REGULATIONS. DIVERSION CONTRARY TO U.S. LAW PROHIBITED.

TITLE

0 to 90 dB Step Attenuator 50 Ohm BNC Female To 50 Ohm BNC Female With 1 dB Step Rated To 2 Watts Up To 1 GHz in a Push Button design

UNLESS OTHERWISE SPECIFIED LEADING DIMENSIONS ARE INCHES
DIMENSIONS IN [] ARE MILLIMETERS

TOLERANCES:

.X = ±.2 [5.08] FRACTIONS ± 1/32
.XX = ±.02 [.51]
.XXX = ±.005 [.13]

ANGLES ± 1°

CABLE LENGTH (L) TOLERANCES:

L ≤ 12 [305] = +1 [25] / -0
12 [305] < L ≤ 60 [1524] = +2 [51] / -0
60 [1524] < L ≤ 120 [3048] = +4 [102] / -0
120 [3048] < L ≤ 300 [7620] = +6 [152] / -0
300 [7620] < L = +5%L / -0

THIRD-ANGLE PROJECTION



THE INFORMATION AND DESIGN IN THIS DOCUMENT IS THE PROPERTY OF FAIRVIEW MICROWAVE CORPORATION. ALL RIGHTS RESERVED.

SHEET 1 OF 1

SCALE N/A

ALL DIMENSIONS SHOWN ARE FOR REFERENCE ONLY.

SIZE A	CAGE CODE 3FKR5	DRAWN BY VTHANGARAJ	ITEM NO. FMAT1040B	REV A
-----------	--------------------	------------------------	-----------------------	----------

T-Rev.D