

Data sheet | Item number: 221-525

Mounting carrier; for 5-conductor terminal blocks; 221 Series - 4 mm²; with snap-in mounting foot for vertical mounting; white

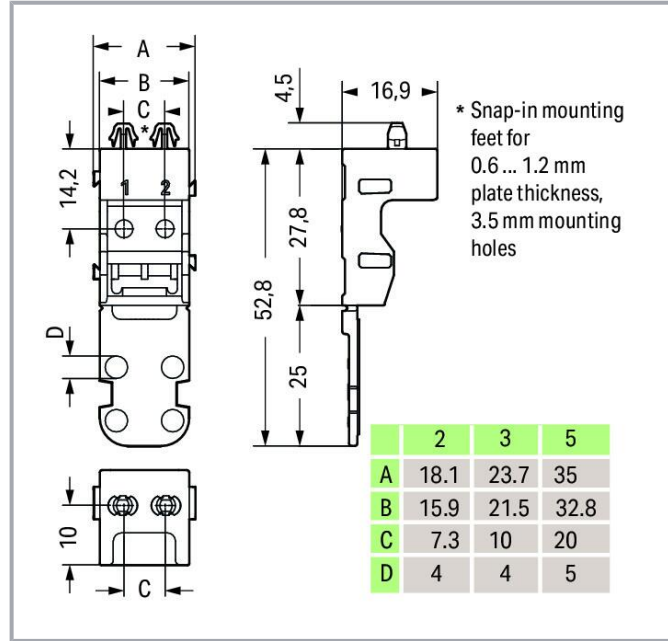

www.wago.com/221-525

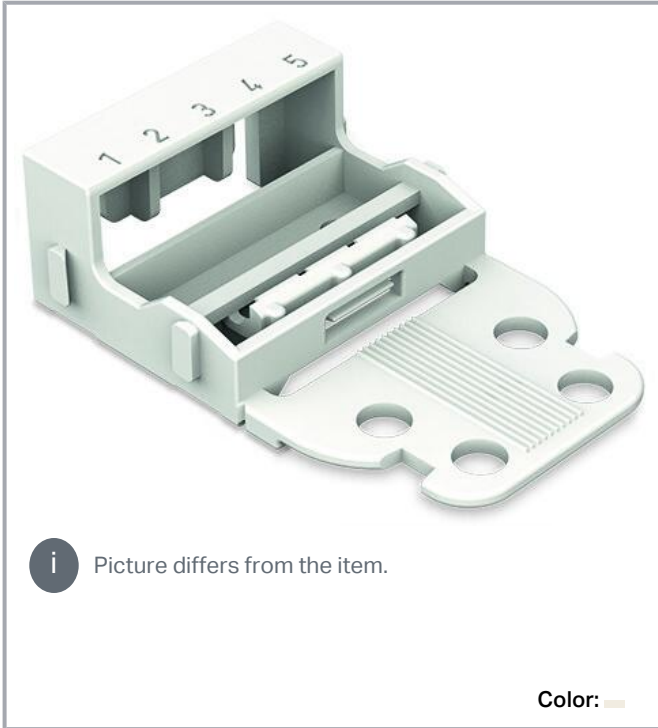

Data

Physical data

Width	35 mm / 1.378 inches
Height	57.3 mm / 2.256 inches
Depth	16.9 mm / 0.665 inches

Mechanical data

Mounting type	with snap-in mounting foot for vertical mounting
Suitable	for 5-wire connectors (4 mm ²)

Material data

Note (material data)

[Information on material specifications can be found here](#)

Subject to changes. Please also observe the further product documentation!

WAGO GmbH & Co. KG
Hansastr. 27
32423 Minden
Phone: +49571 887-0 | Fax: +49571 887-169
Email: info.de@wago.com | Web: www.wago.com

Do you have any questions about our products?
We are always happy to take your call at +49 (571) 887-44222.

Color	white
Material group	I
Insulation material	Polyamide (PA66)
Flammability class per UL94	V0
Fire load	0.152 MJ
Weight	5.1 g

Commercial data

eCl@ss 10.0	27-14-11-92
eCl@ss 9.0	27-14-11-92
ETIM 8.0	EC002848
ETIM 7.0	EC002848
ECCN	NO DATA
PU (SPU)	50 (10) pcs
Packaging type	box
Country of origin	CN
GTIN	4055143640961
Customs tariff number	39269097900

Environmental Product Compliance

RoHS Compliance Status	Compliant, No Exemption
------------------------	-------------------------

Optional accessories

Marking accessories

Marking strip



Item no.: 210-833

Marking strips; 25 m on roll; 6 mm wide; plain; Self-adhesive; white

www.wago.com/210-833

Downloads

Documentation

Bid Text

221-525 X81 - Datei	2019 年2月19日	xml 2.8 kB	Download
221-525 doc - Datei	2018 年1月4日	doc 24.6 kB	Download

Subject to changes. Please also observe the further product documentation!

WAGO GmbH & Co. KG
 Hansastr. 27
 32423 Minden
 Phone: +49571 887-0 | Fax: +49571 887-169
 Email: info.de@wago.com | Web: www.wago.com

Do you have any questions about our products?
 We are always happy to take your call at +49 (571) 887-44222.

CAD/CAE-Data

CAD data

2D/3D Models 221-525	URL	Download
----------------------	---------------------	--------------------------

CAE data

ZUKEN Portal 221-525	URL	Download
----------------------	---------------------	--------------------------

EPLAN Data Portal 221-525	URL	Download
---------------------------	---------------------	--------------------------

Asset Administration Shell

Asset Administration Shell 221-525	URL	Download
------------------------------------	---------------------	--------------------------

Environmental Product Compliance

Compliance Search

Environmental Product Compliance 221-525	URL	Download
--	---------------------	--------------------------

Mounting carrier; for 5-conductor terminal blocks; 221 Series - 4 mm²; with snap-in mounting foot for vertical mounting; white

Installation Notes

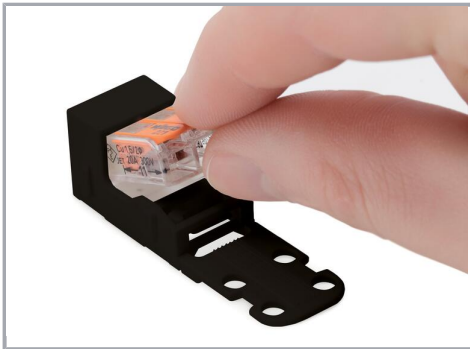

Inserting a connector into the mounting carrier.

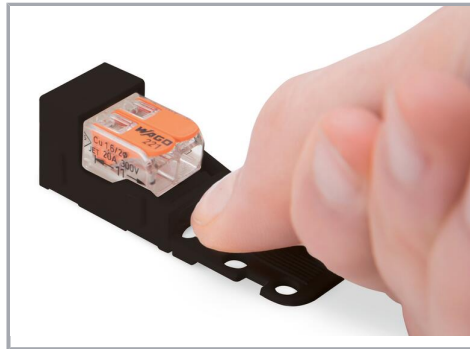

Removing a connector from the mounting carrier.

Conductor termination

Subject to changes. Please also observe the further product documentation!

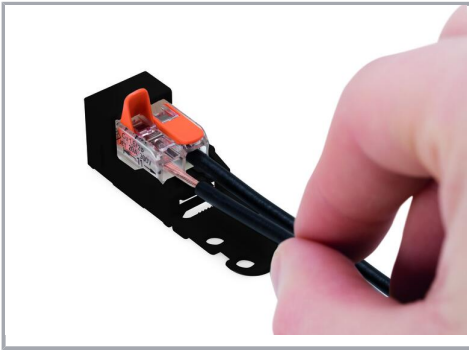

Inserting a conductor.



Horizontal screw mounting



Vertical screw mounting



Horizontal mounting via snap-in foot



Vertical mounting via snap-in foot

Strain relief

Subject to changes. Please also observe the further product documentation!



Use a cable tie to secure the conductors to the strain relief plate.



The strain relief plate can be removed.

Testing

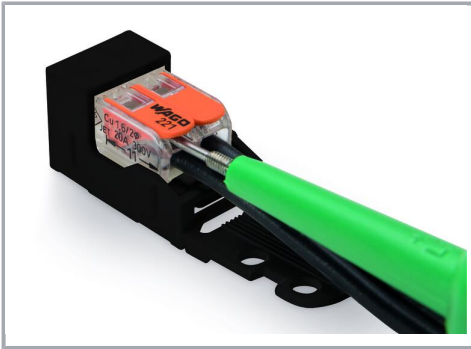

Testing a connector mounted on the carrier via test slot.

Application



Connecting a light to the mains.

Marking

Subject to changes. Please also observe the further product documentation!

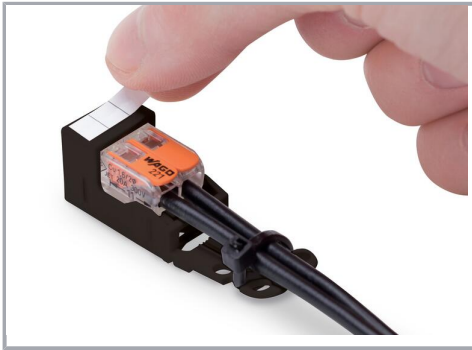

Labeling the mounting carrier.

Subject to changes. Please also observe the further product documentation!