

R88M-G□

# G-Series servo motors

**A wide range of compact servomotors to meet all application needs**

- Peak torque 300% of continuous torque during 3 seconds or more depending on model
- Servomotors supported by SmartStep2, G-Series and Accurax G5 servo drives
- Cylindrical and flat servomotors types are available
- Encoder accuracy of 10,000 step/rev as standard and 17-bit INC/ABS encoder as optional
- IP65 as standard and shaft oil seal available
- Motors with brake as option

**Ratings**

- 230 VAC single-phase 50 W to 1.5 kW (rated torque from 0.16 to 8.62 Nm)



**System configuration**

(Refer to servo drive chapter)

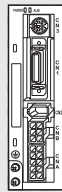

**SmartStep 2**  
Servo drive controlled by pulses (100 to 750 W)

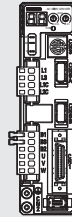

Drive options

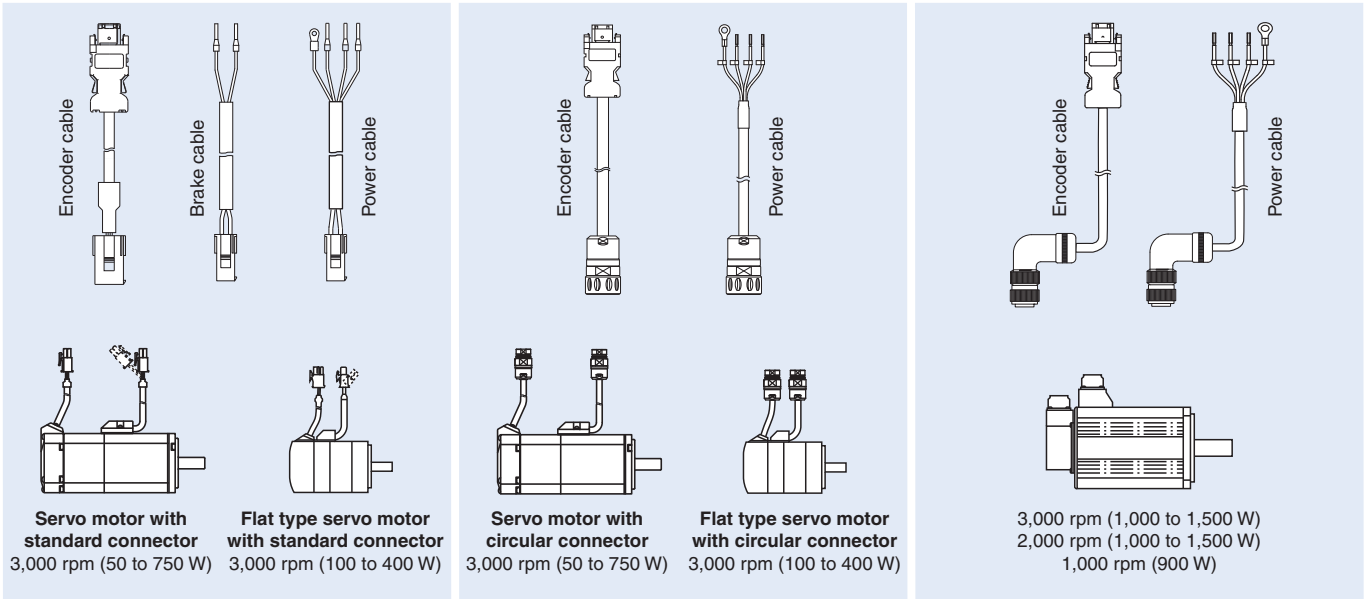

**G-Series servo drive**  
ML2 and analogue/pulse models (100 to 1,500 W)



## Servo motor/servo drive combination

		Servo motor					Servo drive		
Family		Voltage	Speed	Rated torque	Capacity	Model	SmartStep2 <sup>3</sup>	G-Series ML2	G-Series A/P
Cylindric	50 to 750 W 	230 V	3,000 min <sup>-1</sup>	0.16 Nm	50 W	R88M-G05030□-□S2-□	R7D-BP01H	R88D-GN01H-ML2	R88D-GT01H
				0.32 Nm	100 W	R88M-G10030□-□S2-□	R7D-BP01H	R88D-GN01H-ML2	R88D-GT01H
				0.64 Nm	200 W	R88M-G20030□-□S2-□	R7D-BP02HH	R88D-GN02H-ML2	R88D-GT02H
				1.3 Nm	400 W	R88M-G40030□-□S2-□	R7D-BP04H	R88D-GN04H-ML2	R88D-GT04H
				2.4 Nm	750 W	R88M-G75030□-□S2-□	R88D-GP08H	R88D-GN08H-ML2	R88D-GT08H
	900 to 1500 W 		2,000 min <sup>-1</sup>	3.18 Nm	1,000 W	R88M-G1K030T-□S2	-	R88D-GN15H-ML2	R88D-GT15H
				4.77 Nm	1,500 W	R88M-G1K530T-□S2	-	R88D-GN15H-ML2	R88D-GT15H
				4.8 Nm	1,000 W	R88M-G1K020T-□S2	-	R88D-GN10H-ML2	R88D-GT10H
					1,500 W	R88M-G1K520T-□S2	-	R88D-GN15H-ML2	R88D-GT15H
				8.62 Nm	900 W	R88M-G90010T-□S2	-	R88D-GN15H-ML2	R88D-GT15H
Flat	100 to 400 W 	3,000 min <sup>-1</sup>	0.32 Nm	100 W	R88M-GP10030□-□S2-□	R7D-BP01H	R88D-GN01H-ML2	R88D-GT01H	
			0.64 Nm	200 W	R88M-GP20030□-□S2-□	R7D-BP02HH	R88D-GN02H-ML2	R88D-GT02H	
			1.3 Nm	400 W	R88M-GP40030□-□S2-□	R7D-BP04H	R88D-GN04H-ML2	R88D-GT04H	

- Note:**
1. For servo motor and cables part numbers refer to ordering information at the end of this chapter
  2. Refer to the servo drive chapter for drive options selection and detailed specifications
  3. SmartStep2 only supports incremental encoder

## Type designation

### Servo motor

# R88M-GP10030H-BOS2-D

G-Series servo motor

Motor type

Blank	Cylinder type
P	Flat type

Capacity

050	50 W
100	100 W
200	200 W
400	400 W
750	750 W
900	900 W
1K0	1 kW
1K5	1.5 kW

Rated speed (r/min)

10	1,000
20	2,000
30	3,000

Connector type

Blank	Standard connector
D	Circular connector

Shaft end specifications

Blank	Straight shaft, no key
S2	Straight, key, tapped

Oil seal specifications

Blank	No oil seal
O	Oil seal

Brake specifications

Blank	No brake
B	Brake

Voltage and encoder specifications

H	230 V with incremental encoder
T	230 V with absolute encoder

**Servo motor specifications**

**Cylindrical servo motors 3,000/2,000/1,000 r/min**

**Ratings and specifications**

Applied voltage		230 V									
Servo motor model R88M-□		G05030	G10030	G20030	G40030	G75030	G1K030T	G1K530T	G1K020T	G1K520T	G90010T
Rated output	W	50	100	200	400	750	1,000	1,500	1,000	1,500	900
Rated torque	N·m	0.16	0.32	0.64	1.3	2.4	3.18	4.77	4.8	7.15	8.62
Instantaneous peak torque	N·m	0.45	0.90	1.78	3.67	7.05	9.1	12.8	13.5	19.6	18.4
Rated current	A (rms)	1.1		1.6	2.6	4	7.2	9.4	5.6	9.4	7.6
Instantaneous max. current	A (rms)	3.4		4.9	7.9	12.1	21.4	28.5	17.1	28.5	17.1
Rated speed	min <sup>-1</sup>	3,000							2,000		1,000
Max. speed	min <sup>-1</sup>	5,000				4,500	5,000		3,000		2,000
Torque constant	N·m/A (rms)	0.14	0.19	0.41	0.51	0.64	0.44	0.51	0.88	0.76	1.13
Rotor moment of inertia (JM)	kg·m <sup>2</sup> ×10 <sup>-4</sup>	0.025	0.051	0.14	0.26	0.87	1.69	2.59	6.17	11.2	
Allowable load moment of inertia (JL)	Multiple of (JM)	30				20	15		10		
Rated power rate	kW/s	10.4	20.1	30.3	62.5	66	60	88	37.3	45.8	66.3
Applicable encoder		Incremental encoder (10,000 pulses)					-				
		Incremental/absolute encoder (17 bits)									
Allowable radial load	N	68		245		392		490		686	
Allowable thrust load	N	58		98		147		196			
Approx. mass	kg (without brake)	0.3	0.5	0.8	1.2	2.3	4.5	5.1	6.8	8.5	
	kg (with brake)	0.5	0.7	1.3	1.7	3.1	5.1	6.5	8.7	10.1	10
Brake specifications	Rated voltage	24 VDC±5%					24 VDC±10%				
	Holding brake moment of inertia J	0.002		0.018		0.075	0.25	0.33	1.35		
	Power consumption (at 20°C)	7		9		10	18	19	14	19	
	Current consumption (at 20°C)	0.3		0.36		0.42	0.74	0.81	0.59	0.79	
	Static friction torque	0.29		1.27		2.45	4.9	7.8	4.9	13.7	
	Rise time for holding torque	35		50		70	50		80	100	
Release time	20		15		20	15		70	50		
Basic specifications	Rating	Continuous									
	Insulation grade	Type B					Type F				
	Ambient operating/storage temperature	0 to 40°C/-20 to 65°C					0 to 40°C/-20 to 80°C				
	Ambient operating/storage humidity	85% RH max. (non-condensing)									
	Vibration class	V-15									
	Insulation resistance	20 MΩ min. at 500 VDC between the power terminals and FG terminal									
	Enclosure	Totally-enclosed, self-cooling, IP65 (excluding shaft opening and lead wire ends)									
	Vibration resistance	Vibration acceleration 49 m/s <sup>2</sup>					Vibration acceleration 24.5 m/s <sup>2</sup>				
Mounting	Flange-mounted										

**Torque-speed characteristics**

R88M-G05030H/T (50 W)

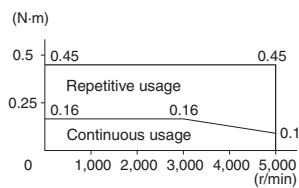

R88M-G10030H/T (100 W)

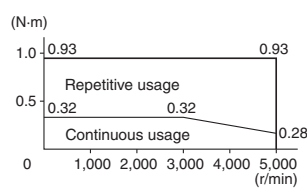

R88M-G20030H/T (200 W)

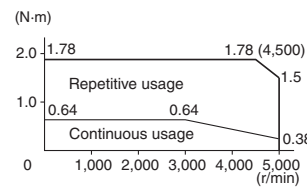

R88M-G40030H/T (400 W)

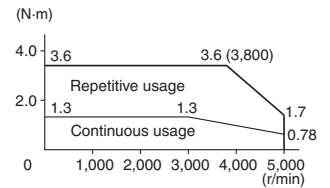

R88M-G75030H/T (750 W)

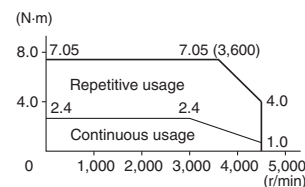

R88M-G1K030T (1 kW)

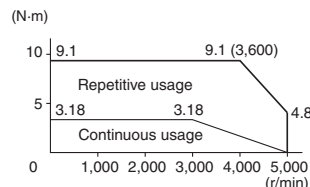

R88M-G1K530T (1.5 kW)

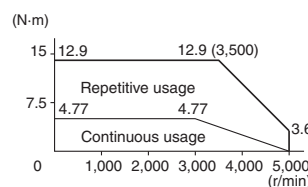

R88M-G1K020T (1 kW)

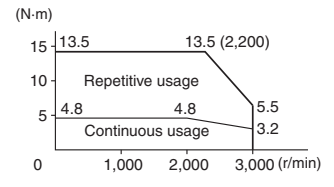

R88M-G1K520T (1.5 kW)

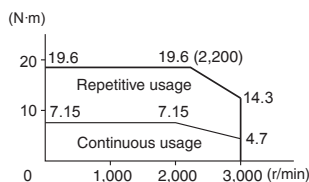

R88M-G90010T (900 W)

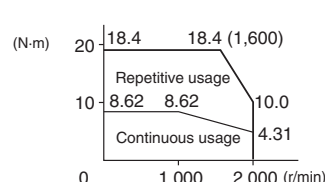

## Flat servo motors 3,000 r/min

### Ratings and specifications

Applied voltage		230 V		
Servo motor model R88M-□		GP10030□	GP20030□	GP40030□
Rated output	W	100	200	400
Rated torque	N·m	0.32	0.64	1.3
Instantaneous peak torque	N·m	0.86	1.8	3.65
Rated current	A (rms)	1	1.6	2.5
Instantaneous max. current	A (rms)	3.1	4.9	7.5
Rated speed	min <sup>-1</sup>	3,000		
Max. speed	min <sup>-1</sup>	5,000		
Torque constant	N·m/A (rms)	0.34	0.42	0.54
Rotor moment of inertia (JM)	kg·m <sup>2</sup> × 10 <sup>-4</sup>	0.1	0.35	0.64
Allowable load moment of inertia (JL)	Multiple of (JM)	20		
Rated power rate	kW/s	10.2	11.5	25.5
Applicable encoder		Incremental (10,000 pulses)		
		Incremental/absolute encoder (17 bits)		
Allowable radial load	N	68	245	
Allowable thrust load	N	58	98	
Approx. mass	kg (without brake)	0.7	1.3	1.8
	kg (with brake)	0.9	2	2.5
Brake specifications	Rated voltage	24VDC±10%		
	Holding brake moment of inertia J	kg·m <sup>2</sup> × 10 <sup>-4</sup>	0.03	0.09
	Power consumption (at 20°C)	W	7	10
	Current consumption (at 20°C)	A	0.29	0.41
	Static friction torque	N·m (minimum)	0.29	1.27
	Rise time for holding torque	ms (max.)	50	60
	Release time	ms (max)	15	
Basic specifications	Rating	Continuous		
	Insulation grade	Type B		
	Ambient operating/storage temperature	0 to 40°C/-20 to 80°C		
	Ambient operating/storage humidity	85% RH max. (non-condensing)		
	Vibration class	V-15		
	Insulation resistance	20 MΩ min. at 500 VDC between the power terminals and FG terminal		
	Enclosure	Totally-enclosed, self-cooling, IP65 (excluding shaft opening and lead wire ends)		
	Vibration resistance	Vibration acceleration 49 m/s <sup>2</sup>		
Mounting	Flange-mounted			

### Torque-speed characteristics

R88M-GP10030H/T (100 W)

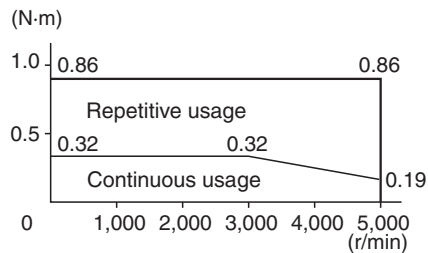

R88M-GP20030H/T (200 W)

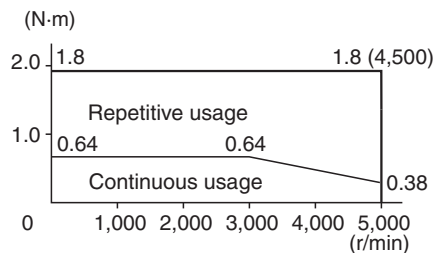

R88M-GP40030H/T (400 W)

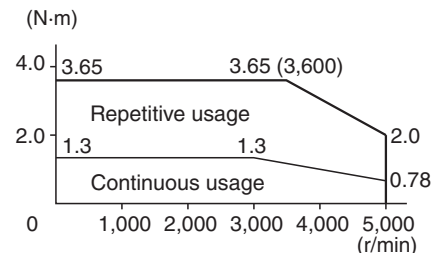

Dimensions

Servo motors

Cylindrical type 3,000 r/min (230 V, 50 to 100 W)

Dimensions (mm)	Without brake	With brake	LN	Flange surface			Shaft end		Aprox. mass (kg)	
				D	S	B	Without brake	With brake		
R88M-G05030□-□S2-□	72	102	26.5	30 <sup>h7</sup>	8 <sup>h6</sup>	3 <sup>h9</sup>	0.3	0.5		
R88M-G10030□-□S2-□	92	122	46.5				0.5	0.7		

Servo motor with standard connector

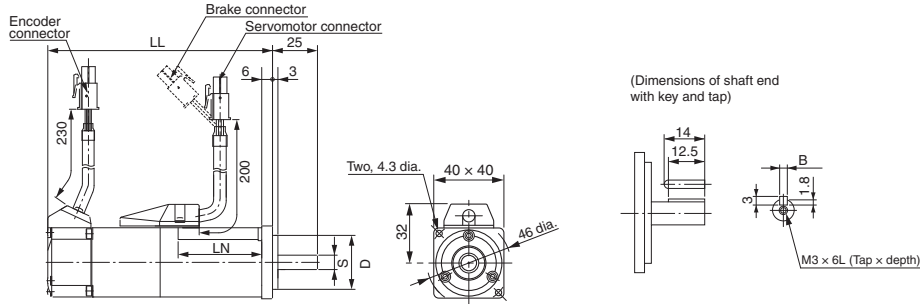

(Dimensions of shaft end with key and tap)

Servo motor with circular connector

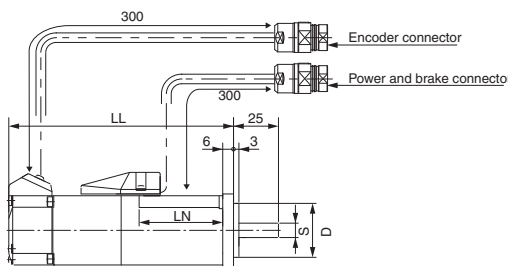

Encoder connector wiring



Pin No.	Signal
1	BAT - (0 V)
2	BAT +
3	S +
4	S -
5 to 7	Free
8	ESV (power supply)
9	EOV (power supply)
10 to 17	Free
Connector case	FG (Ground)

\*Note: Pins 1 and 2 used only for motors with ABS encoder.

Power and brake connector wiring

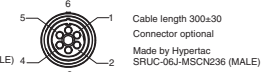

Pin No.	Output
1	Phase U
2	Phase V
3	Phase W
4	*Brake terminal
5	*Brake terminal
6	FG (ground)

\*Note: Pins 4 and 5 used only for motors with brake.

Mating connector: Plug type: SPOC-17H-FRON169 (FEMALE)

Mating connector: Plug type: SPOC-06K-FSDN169 (FEMALE)

Cylindrical type 3,000 r/min (230 V, 200 to 750 W)

Dimensions (mm)	Without brake	With brake	LR	KL1	Flange surface					Shaft end					Aprox. mass (kg)		
					D1	D2	C	G	Z	S	QK	B	H	T1	Tap x depth	Without brake	With brake
R88M-G20030□-□S2-□	79.5	116	30	43	70	50 <sup>h7</sup>	60	6.5	4.5	11 <sup>h6</sup>	18	4 <sup>h9</sup>	4	2.5	M4 x 8L	0.8	1.3
R88M-G40030□-□S2-□	99	135.5								14 <sup>h6</sup>	22.5	5 <sup>h9</sup>	5	3	M5 x 10L	1.2	1.7
R88M-G75030□-□S2-□	112.2	149.2	35	53	90	70 <sup>h7</sup>	80	8	6	19 <sup>h6</sup>	22	6 <sup>h9</sup>	6	3.5		2.3	3.1

Servo motor with standard connector

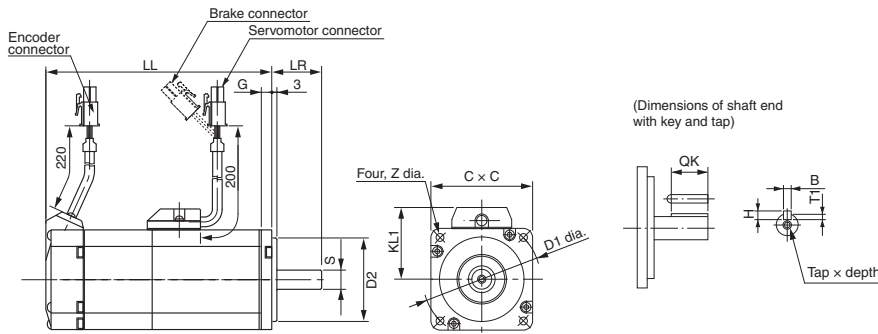

(Dimensions of shaft end with key and tap)

Servo motor with circular connector

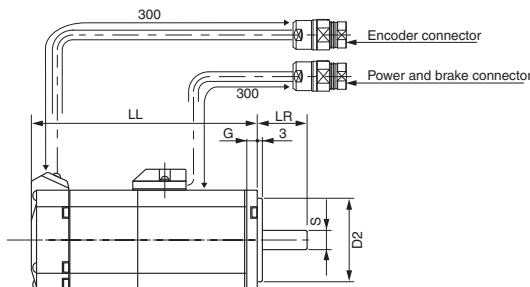

Encoder connector wiring



Pin No.	Signal
1	BAT - (0 V)
2	BAT +
3	S +
4	S -
5 to 7	Free
8	ESV (power supply)
9	EOV (power supply)
10 to 17	Free
Connector case	FG (Ground)

\*Note: Pins 1 and 2 used only for motors with ABS encoder.

Power and brake connector wiring

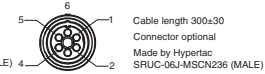

Pin No.	Output
1	Phase U
2	Phase V
3	Phase W
4	*Brake terminal
5	*Brake terminal
6	FG (ground)

\*Note: Pins 4 and 5 used only for motors with brake.

Mating connector: Plug type: SPOC-17H-FRON169 (FEMALE)

Mating connector: Plug type: SPOC-06K-FSDN169 (FEMALE)

## Cylindrical type 3,000, 2,000 and 1,000 r/min (230 V, 900 kW to 1.5 kW)

Dimensions (mm)	Without brake	With brake	LR	KL1	Flange surface								Shaft end					Aprox. mass (kg)	
					D1	D2	D3	C	G	F	Z	S	QK	B	H	T1	Tap x depth	Without brake	With brake
R88M-G1K030T-□S2	175	200	55	98	100	80 <sup>h7</sup>	120	90	7	3	6.6	19 <sup>h6</sup>	42	6 <sup>h9</sup>	6	3.5	M5 x 12L	4.5	5.1
R88M-G1K530T-□S2	180	205		103	115	95 <sup>h7</sup>	135	100	10	9	9	19 <sup>h6</sup>	42	6 <sup>h9</sup>	6	3.5		5.1	6.5
R88M-G1K020T-□S2	150	175		118	145	110 <sup>h7</sup>	165	130	12	6	6	22 <sup>h6</sup>	41	8 <sup>h9</sup>	7	4		6.8	8.7
R88M-G1K520T-□S2	175	200		70														8.5	10.1
R88M-G90010T-□S2	175	200	70																10

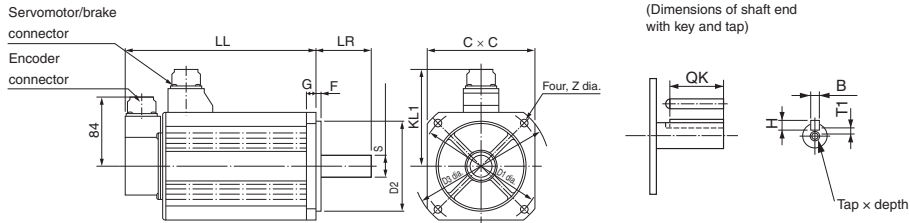

## Flat type 3000 r/min (230 V, 100 W - 400 W)

Dimensions (mm)	Without brake	With brake	LR	KL1	Flange surface							Shaft end					Aprox. mass (kg)	
					D1	D2	C	F	G	Z	S	QK	B	H	T1	Tap x depth	Without brake	With brake
R88M-GP10030H-□S2-□	60.5	84.5	25	43	70	50 <sup>h7</sup>	60	3	7	4.5	8 <sup>h6</sup>	12.5	3 <sup>h9</sup>	3	1.8	M3x6L	0.7	0.9
R88M-GP10030T-□S2-□	87.5	111.5																
R88M-GP20030H-□S2-□	67.5	100	30	53	90	70 <sup>h7</sup>	80	5	8	5.5	11 <sup>h6</sup>	18	4 <sup>h9</sup>	4	2.5	M4x8L	1.3	2
R88M-GP20030T-□S2-□	94.5	127																
R88M-GP40030H-□S2-□	82.5	115									14 <sup>h6</sup>	22.5	5 <sup>h9</sup>	5	3.0	M5x10L	1.8	2.5
R88M-GP40030T-□S2-□	109.5	142																

### Servo motor with standard connector

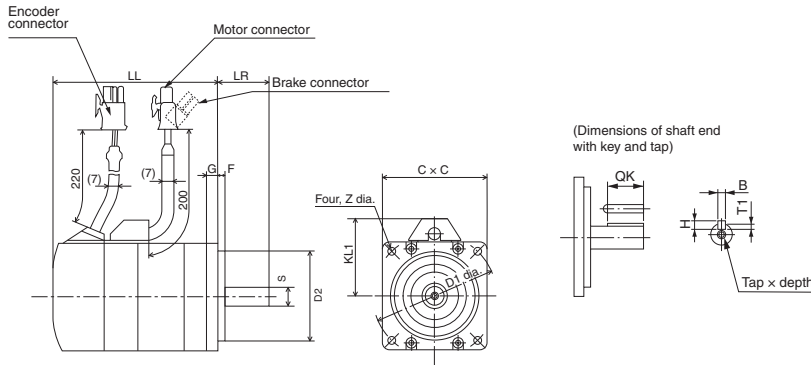

### Servo motor with circular connector

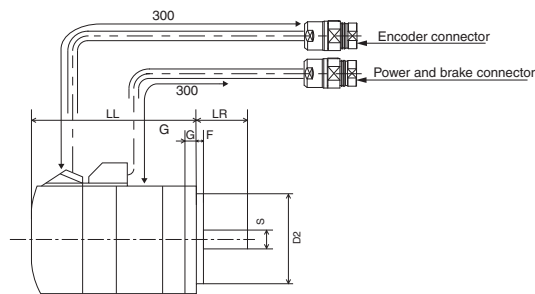

### Encoder connector wiring



Cable length 300±30  
Connector optional  
Made by Hypertac  
SRUC-17G-MRW087 (MALE)

Pin No.	Signal
1	BAT - (0 V)
2	BAT +
3	S +
4	S -
5 to 7	Free
8	ESV (power supply)
9	EGV (power supply)
10 to 17	Free
Connector case	FG (Ground)

\*Note: Pins 1 and 2 used only for motors with ABS encoder.

Mating connector:  
Plug type: SPOC-17H-FRON169 (FEMALE)

### Power and brake connector wiring



Cable length 300±30  
Connector optional  
Made by Hypertac  
SRUC-06J-MSCN236 (MALE)

Pin No.	Output
1	Phase U
2	Phase V
3	Phase W
4	*Brake terminal
5	*Brake terminal
6	FG (ground)

\*Note: Pins 4 and 5 used only for motors with brake.

Mating connector:  
Plug type: SPOC-06K-FSDN169 (FEMALE)

Ordering information

(Refer to servo drive chapter)

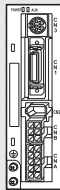

**SmartStep 2**  
Servo drive controlled by pulses (100 to 750 W)

Drive options ②

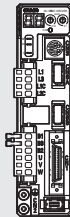

**G-Series servo drive**  
ML2 and analogue/pulse models (100 to 1,500 W)

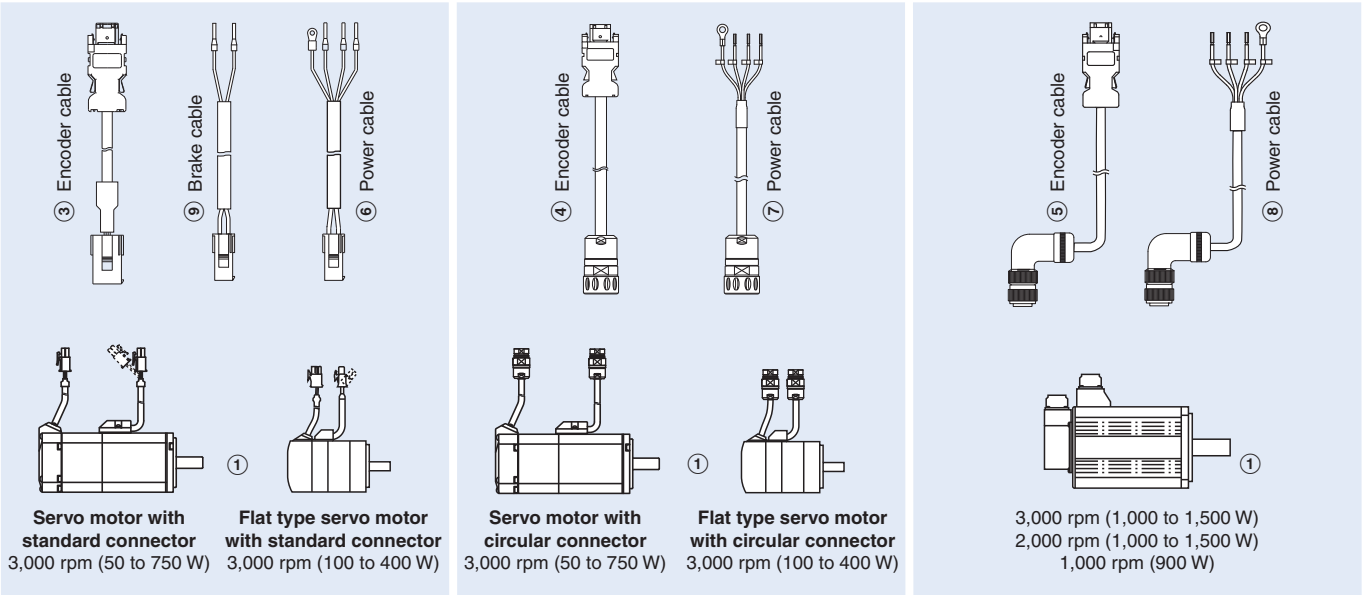

Servo motor

① Select motor from cylindrical and flat types using motor tables in next pages.

Servo drive

② Refer to G-Series and SmartStep2 servo drive chapters for detailed drive specifications and selection of drive accessories.

Cylindrical servo motors 3,000/2,000/1,000 r/min (230 V, 50 to 1.5 kW)

Symbol	Specifications					Servo motor		Compatible servo drives ②	
	Encoder and design	Speed	Design	Rated torque	Capacity	Model with standard connector	Model with circular connector	SmartStep 2	G-Series
 (50 to 750 W)	Incremental encoder (10,000 pulses)  Straight shaft with key and tap	3,000 min <sup>-1</sup>	Without brake	0.16 Nm	50 W	R88M-G05030H-S2	R88M-G05030H-S2-D	R7D-BP01H	R88D-G□01H□
				0.32 Nm	100 W	R88M-G10030H-S2	R88M-G10030H-S2-D	R7D-BP01H	R88D-G□01H□
				0.64 Nm	200 W	R88M-G20030H-S2	R88M-G20030H-S2-D	R7D-BP02HH	R88D-G□02H□
				1.3 Nm	400 W	R88M-G40030H-S2	R88M-G40030H-S2-D	R7D-BP04H	R88D-G□04H□
				2.4 Nm	750 W	R88M-G75030H-S2	R88M-G75030H-S2-D	R88D-GP08H	R88D-G□08H□
				0.16 Nm	50 W	R88M-G05030H-BS2	R88M-G05030H-BS2-D	R7D-BP01H	R88D-G□01H□
			With brake	0.32 Nm	100 W	R88M-G10030H-BS2	R88M-G10030H-BS2-D	R7D-BP01H	R88D-G□01H□
				0.64 Nm	200 W	R88M-G20030H-BS2	R88M-G20030H-BS2-D	R7D-BP02HH	R88D-G□02H□
				1.3 Nm	400 W	R88M-G40030H-BS2	R88M-G40030H-BS2-D	R7D-BP04H	R88D-G□04H□
				2.4 Nm	750 W	R88M-G75030H-BS2	R88M-G75030H-BS2-D	R88D-GP08H	R88D-G□08H□

Symbol	Specifications					Servo motor		Compatible servo drives (2)	
	Encoder and design	Speed	Design	Rated torque	Capacity	Model with standard connector	Model with circular connector	SmartStep 2	G-Series
 <p>(50 to 750 W)</p> <p>(900 to 1500 W)</p>	Absolute/incremental encoder (17 bits)	3,000 min <sup>-1</sup>	Without brake	0.16 Nm	50 W	R88M-G05030T-S2	R88M-G05030T-S2-D	-	R88D-G□01H□
				0.32 Nm	100 W	R88M-G10030T-S2	R88M-G10030T-S2-D	-	R88D-G□01H□
				0.64 Nm	200 W	R88M-G20030T-S2	R88M-G20030T-S2-D	-	R88D-G□02H□
				1.3 Nm	400 W	R88M-G40030T-S2	R88M-G40030T-S2-D	-	R88D-G□04H□
				2.4 Nm	750 W	R88M-G75030T-S2	R88M-G75030T-S2-D	-	R88D-G□08H□
				3.18 Nm	1 kW	R88M-G1K030T-S2	-	-	R88D-G□15H□
			4.77 Nm	1.5 kW	R88M-G1K530T-S2	-	-	R88D-G□15H□	
			With brake	0.16 Nm	50 W	R88M-G05030T-BS2	R88M-G05030T-BS2-D	-	R88D-G□01H□
				0.32 Nm	100 W	R88M-G10030T-BS2	R88M-G10030T-BS2-D	-	R88D-G□01H□
				0.64 Nm	200 W	R88M-G20030T-BS2	R88M-G20030T-BS2-D	-	R88D-G□02H□
				1.3 Nm	400 W	R88M-G40030T-BS2	R88M-G40030T-BS2-D	-	R88D-G□04H□
				2.4 Nm	750 W	R88M-G75030T-BS2	R88M-G75030T-BS2-D	-	R88D-G□08H□
	3.18 Nm	1 kW		R88M-G1K030T-BS2	-	-	R88D-G□15H□		
	2000 min <sup>-1</sup>	Without brake	4.8 Nm	1 kW	R88M-G1K020T-S2	-	-	R88D-G□10H□	
					R88M-G1K520T-S2	-	-	R88D-G□15H□	
					R88M-G1K520T-BS2	-	-	R88D-G□15H□	
		With brake	4.8 Nm	1 kW	R88M-G1K020T-BS2	-	-	R88D-G□10H□	
					R88M-G1K520T-BS2	-	-	R88D-G□15H□	
R88M-G1K520T-BS2					-	-	R88D-G□15H□		
1000 min <sup>-1</sup>	Without brake	8.62 Nm	900 W	R88M-G90010T-S2	-	-	R88D-G□15H□		
				R88M-G90010T-BS2	-	-	R88D-G□15H□		

Flat type servo motors 3,000 r/min (230 V, 100 to 400 W)

Symbol	Specifications				Servo motor		Compatible servo drives (2)		
	Encoder and design		Rated torque	Capacity	Model with standard connector	Model with circular connector	SmartStep 2	G-Series	
	Incremental encoder (10,000 pulses)	Without brake	0.32 Nm	100 W	R88M-GP10030H-S2	R88M-GP10030H-S2-D	R7D-BP01H	R88D-G□01H□	
			0.64 Nm	200 W	R88M-GP20030H-S2	R88M-GP20030H-S2-D	R7D-BP02HH	R88D-G□02H□	
			1.3 Nm	400 W	R88M-GP40030H-S2	R88M-GP40030H-S2-D	R7D-BP04H	R88D-G□04H□	
			With brake	0.32 Nm	100 W	R88M-GP10030H-BS2	R88M-GP10030H-BS2-D	R7D-BP01H	R88D-G□01H□
				0.64 Nm	200 W	R88M-GP20030H-BS2	R88M-GP20030H-BS2-D	R7D-BP02HH	R88D-G□02H□
				1.3 Nm	400 W	R88M-GP40030H-BS2	R88M-GP40030H-BS2-D	R7D-BP04H	R88D-G□04H□
	Absolute/incremental encoder (17 bits)	Without brake	0.32 Nm	100 W	R88M-GP10030T-S2	R88M-GP10030T-S2-D	-	R88D-G□01H□	
			0.64 Nm	200 W	R88M-GP20030T-S2	R88M-GP20030T-S2-D	-	R88D-G□02H□	
			1.3 Nm	400 W	R88M-GP40030T-S2	R88M-GP40030T-S2-D	-	R88D-G□04H□	
			With brake	0.32 Nm	100 W	R88M-GP10030T-BS2	R88M-GP10030T-BS2-D	-	R88D-G□01H□
				0.64 Nm	200 W	R88M-GP20030T-BS2	R88M-GP20030T-BS2-D	-	R88D-G□02H□
				1.3 Nm	400 W	R88M-GP40030T-BS2	R88M-GP40030T-BS2-D	-	R88D-G□04H□

Encoder cables

For 50 to 750 W servo motors with standard connector

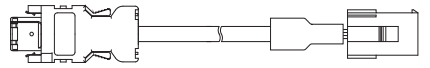
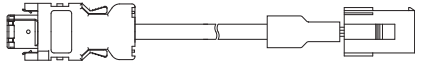
Symbol	Specifications	Length	Model	Appearance	
③	Encoder cable (50 to 750 W) R88M-G(50/100/200/400/750)30□-□□□-D R88M-GP(100/200/400)30□-□□□-D	Absolute encoder T-□	1.5 m	R88A-CRGA001-5CR-E	
			3 m	R88A-CRGA003CR-E	
			5 m	R88A-CRGA005CR-E	
			10 m	R88A-CRGA010CR-E	
			15 m	R88A-CRGA015CR-E	
			20 m	R88A-CRGA020CR-E	
		Incremental encoder H-□	1.5 m	R88A-CRGB001-5CR-E	
			3 m	R88A-CRGB003CR-E	
			5 m	R88A-CRGB005CR-E	
			10 m	R88A-CRGB010CR-E	
			15 m	R88A-CRGB015CR-E	
			20 m	R88A-CRGB020CR-E	

For 50 to 750 W servo motors with circular connector

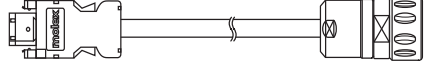
Symbol	Specifications	Length	Model	Appearance
④	Encoder cable (50 to 750 W) R88M-G(50/100/200/400/750)30□-□□□-D R88M-GP(100/200/400)30□-□□□-D	3 m	R88A-CRWA003C-DE	
		5 m	R88A-CRWA005C-DE	
		10 m	R88A-CRWA010C-DE	
		15 m	R88A-CRWA015C-DE	
		20 m	R88A-CRWA020C-DE	

For 900 to 1500 W servo motors

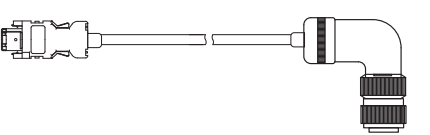
Symbol	Specifications	Length	Model	Appearance
⑤	Encoder cable (900 to 1500 W) R88M-G(1K0/1K5)30T-□ R88M-G(1K0/1K5)20T-□ R88M-G90010T-□	1.5 m	R88A-CRGC001-5NR-E	
		3 m	R88A-CRGC003NR-E	
		5 m	R88A-CRGC005NR-E	
		10 m	R88A-CRGC010NR-E	
		15 m	R88A-CRGC015NR-E	
		20 m	R88A-CRGC020NR-E	



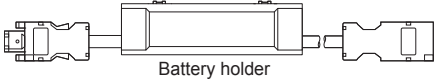

**Battery cable for G-Series servo drive models with absolute encoder**

Symbol	Specifications	Length	Model	Appearance	
	Absolute encoder battery cable	Battery not included	0.3 m	R88A-CRGD0R3C-E	 <p>Battery holder</p>
		Battery included	0.3 m	R88A-CRGD0R3C-BS-E	
	Absolute encoder backup battery 2,000 mA.h 3.6V	–	–	R88A-BAT01G	



**Note:** The absolute encoder battery cable is only an extension and must be used with an absolute encoder cable.

**Power cables**

**For 50 to 750 W servo motors with standard connector**

Symbol	Specifications	Applicable servo drive	Length	Model	Appearance
⑥	For servomotors from 50 to 400 W R88M-G(050/100/200/400)30□ R88M-GP(100/200/400)30□  For servomotors with brake, a separate cable (R88A-CAGA□BR-E) is needed	SmartStep 2	1.5 m	R7A-CAB001-5SR-E	
			3 m	R7A-CAB003SR-E	
			5 m	R7A-CAB005SR-E	
			10 m	R7A-CAB010SR-E	
			15 m	R7A-CAB015SR-E	
			20 m	R7A-CAB020SR-E	
	For servomotors from 50 to 750 W R88M-G(050/100/200/400/750)30□ R88M-GP(100/200/400)30□  For servomotors with brake, a separate cable (R88A-CAGA□BR-E) is needed	SmartStep 2 (only 750 W) and G-Series	1.5 m	R88A-CAGA001-5SR-E	
			3 m	R88A-CAGA003SR-E	
			5 m	R88A-CAGA005SR-E	
			10 m	R88A-CAGA010SR-E	
			15 m	R88A-CAGA015SR-E	
			20 m	R88A-CAGA020SR-E	

**For 50 to 750 W servo motors with circular connectors**

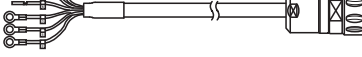
Symbol	Specifications	Applicable servo drive	Length	Model	Appearance
⑦	For servomotors from 50 to 400 W R88M-G(050/100/200/400)30□ R88M-GP(100/200/400)30□	Without brake -S2-D	1.5 m	R7A-CAB001-5SR-DE	
			3 m	R7A-CAB003SR-DE	
			5 m	R7A-CAB005SR-DE	
			10 m	R7A-CAB010SR-DE	
			15 m	R7A-CAB015SR-DE	
		With brake -BS2-D	1.5 m	R7A-CAB001-5BR-DE	
			3 m	R7A-CAB003BR-DE	
			5 m	R7A-CAB005BR-DE	
			10 m	R7A-CAB010BR-DE	
			15 m	R7A-CAB015BR-DE	
	For servomotors from 50 to 750 W R88M-G(050/100/200/400/750)30□ R88M-GP(100/200/400)30□	Without brake -S2-D	3 m	R88A-CAWA003S-DE	
			5 m	R88A-CAWA005S-DE	
			10 m	R88A-CAWA010S-DE	
			15 m	R88A-CAWA015S-DE	
			20 m	R88A-CAWA020S-DE	
		With brake -BS2-D	3 m	R88A-CAWA003B-DE	
			5 m	R88A-CAWA005B-DE	
			10 m	R88A-CAWA010B-DE	
			15 m	R88A-CAWA015B-DE	
			20 m	R88A-CAWA020B-DE	

**For 900 to 1500 W servo motors**

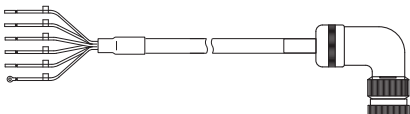
Symbol	Specifications	Applicable servo drive	Length	Model	Appearance
⑧	For servomotors from 900 to 1.5 kW R88M-G(1K0/1K5)30T□ R88M-G(1K0/1K5)20T□ R88M-G90010T□	Without brake -S2	1.5 m	R88A-CAGB001-5SR-E	
			3 m	R88A-CAGB003SR-E	
			5 m	R88A-CAGB005SR-E	
			10 m	R88A-CAGB010SR-E	
			15 m	R88A-CAGB015SR-E	
		With brake -BS2	1.5 m	R88A-CAGB001-5BR-E	
			3 m	R88A-CAGB003BR-E	
			5 m	R88A-CAGB005BR-E	
			10 m	R88A-CAGB010BR-E	
			15 m	R88A-CAGB015BR-E	
	20 m	R88A-CAGB020BR-E			

## Brake cable with standard connector

Symbol	Specifications	Applicable servo drive	Length	Model	Appearance
⑨	Brake cable only For servomotors from 50 to 750W with brake  R88M-G(050/100/200/400/750)30□-BS2, R88M-GP(100/200/400)30□-BS2	SmartStep 2 and G-Series	1.5 m	R88A-CAGA001-5BR-E	
			3 m	R88A-CAGA003BR-E	
			5 m	R88A-CAGA005BR-E	
			10 m	R88A-CAGA010BR-E	
			15 m	R88A-CAGA015BR-E	
			20 m	R88A-CAGA020BR-E	

## Connectors

### Connectors for power, encoder and brake cables

Specifications		Applicable Servomotor	Model		
Connectors for power cable	Drive side (CNB)	-	R88M-G(050/100/200/400)30H□ R88M-GP(100/200/400)30H□	R7A-CNB01A	
	Motor side	Standard connector	R88M-G(050/100/200/400/750)30□ R88M-GP(100/200/400)30□	R88A-CNG01A	
			R88M-G(1K0/1K5)30□-S2 R88M-G(1K0/1K5)20□-S2 R88M-G90010□-S2	MS3108E20-4S	
			R88M-G(1K0/1K5)30□-BS2 R88M-G(1K0/1K5)20□-BS2 R88M-G90010□-BS2	MS3108E20-18S	
			Circular connector (Hypertac)	R88M-G(50/100/200/400/750)30□-□□□-D R88M-GP(100/200/300)□-□□□-D	SPOC-06K-FSDN169
				-	-
Connectors for encoder cable	Drive side (CN2)	-	All models	R88A-CNW01R	
	Motor side	Standard connector	R88M-G(050/100/200/400/750)30T-□ R88M-GP(100/200/400)30T-□	R88A-CNG01R	
			R88M-G(050/100/200/400/750)30H-□ R88M-GP(100/200/400)30H-□	R88A-CNG02R	
			R88M-G(1K0/1K5)30T-□ R88M-G(1K0/1K5)20T-□ R88M-G90010T-□	MS3108E20-29S	
			Circular connector (Hypertac)	R88M-G(50/100/200/400/750)30□-□□□-D R88M-GP(100/200/300)□-□□□-D	SPOC-17H-FRON169
-	-				
Connector for brake cable	Motor side	Standard connector	R88M-G(050/100/200/400/750)30□-BS2 R88M-GP(100/200/400)30□-BS2	R88A-CNG01B	

### Connectors included with the motor

Specifications		Applicable Servomotor	Model
Power and brake connector (MALE)	Circular connector (Hypertac)	R88M-G(50/100/200/400/750)30□-□□□-D R88M-GP(100/200/300)□-□□□-D	SRUC-06J-MSCN236
Encoder connector (MALE)		R88M-G(50/100/200/400/750)30□-□□□-D R88M-GP(100/200/300)□-□□□-D	SRUC-17G-MRWN087

- Note:** 1. All cables listed are flexible and shielded (except the R88A-CAGA□□□BR-E which is only a flexible cable).  
2. The R88A-CRGC□□□NR-E, R88A-CAGB□□□SR-E, R88A-CAGB□□□BR-E, R88A-CRWA□□□C-DE, R88A-CAWA□□□S-DE and R88A-CAWA□□□B-DE cables have IP67 class (including connector).

ALL DIMENSIONS SHOWN ARE IN MILLIMETERS.  
To convert millimeters into inches, multiply by 0.03937. To convert grams into ounces, multiply by 0.03527.