



HELUKABEL®



Cable Accessories

Cable Lugs of Copper and Aluminium

**Data sheets are as of date of print.
You can find the latest versions online
according to this principle:
www.helukabel.com/10001en***

*** Instead of 10001 please insert the wanted part number.**



10-12011

■ TABLE OF CONTENTS

CABLE LUGS	2
HELU-S-RK-CU	4
HELU-S-RK-CU-UL	5
HELU-S-RK-45-CU	7
HELU-S-RK-45-CU-UL	8
HELU-S-RK-90-CU-UL	9
HELU-S-RK-S-CU-UL	11
HELU-S-PK-CU-DIN	12
HELU-S-PK-AL-DIN	14
HELU-S-PK-AL/CU	15
HELU-S-SV-CU	17
HELU-S-PV-CU-DIN	18
HELU-S-PV-AL-DIN	19
HELU-S-PV-AL/CU	20
KAC-U	21
TOOLS	22
HELUTOOL HKS 1	24
HELUTOOL HKS 35	25
HELUTOOL HKS 32	26
HELUTOOL HKS 34 S	27
HELUTOOL HKS 52 S	28
HELUTOOL HKM 1	29
HELUTOOL HAM 1	30
HELUTOOL HWZ 6	31
HELUTOOL HWW 6/50	32
HELUTOOL HWW 10/120	33
HELUTOOL HMPI 20	34
HELUTOOL HHPI 20	35
HELUTOOL HAPI 20	36
HELU-S-PE-WM	37
HELU-S-PE-SK	38
PART NO. INDEX	39
INSTALLATION NOTES	40
COMPRESSION INSTRUCTION WM	41
COMPRESSION INSTRUCTION DIN CU	42
COMPRESSION INSTRUCTION DIN ALU	43
CABLE ACCESSORIES	44

CABLE LUGS



■ TABLE OF CONTENTS

CABLE LUGS	2
HELU-S-RK-CU	4
HELU-S-RK-CU-UL	5
HELU-S-RK-45-CU	7
HELU-S-RK-45-CU-UL	8
HELU-S-RK-90-CU-UL	9
HELU-S-RK-S-CU-UL	11
HELU-S-PK-CU-DIN	12
HELU-S-PK-AL-DIN	14
HELU-S-PK-AL/CU	15
HELU-S-SV-CU	17
HELU-S-PV-CU-DIN	18
HELU-S-PV-AL-DIN	19
HELU-S-PV-AL/CU	20
KAC-U	21

Good to know!

Don't even think about reduction sleeves & special cable lugs



Thanks to the intensive WM-compression, pre-compressed, multi-stranded wires and fine stranded wires can be used in the tubular cable lug.

It can be done without sleeves for compacted conductors exactly as without special cable lugs.

Your advantages:

- cost effective
- easy storage
- 100% safe montage
- time saving

HELU-S-RK-CU Copper tubular cable lug - straight



Tubular cable lug HELU-S-RK-CU

Uninsulated, straight tubular cable lugs in eye type design.

Material

Socket: Copper according to DIN EN 13600
Surface: tin plated

Note

Also available in angulated version (45° and 90°).

Technical data

Temperature range: up to +120°C

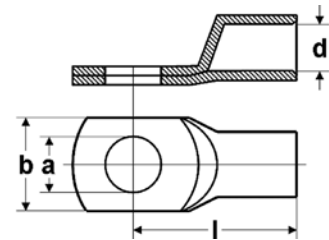

Abmessungen

- a Diameter of the boring
- d Inner diameter of the cable insertion
- b Flange width
- l Length till middle of the boring

Part no.	Type	Cross-section mm ²	a mm	d mm	b mm	l mm	Code type	Weight kg / 1000 items	Unit	Net EUR/100 items at a purchase of		
										up to 100	101 - 500	501 - 1000
907303	HELU-S-RK-CU 0,75-3	0,75	3,2	1,4	6,5	12,5	-	0,7	100	o. r.	o. r.	o. r.
907304	HELU-S-RK-CU 0,75-4	0,75	4,3	1,4	8,5	14,0	-	0,8	100	o. r.	o. r.	o. r.
907305	HELU-S-RK-CU 0,75-5	0,75	5,3	1,4	10,0	15,0	-	1,0	100	o. r.	o. r.	o. r.
907306	HELU-S-RK-CU 1,5-3	1,5	3,2	1,9	6,5	14,0	-	1,2	100	o. r.	o. r.	o. r.
907307	HELU-S-RK-CU 1,5-4	1,5	4,3	1,9	8,5	15,0	-	1,4	100	o. r.	o. r.	o. r.
907308	HELU-S-RK-CU 1,5-5	1,5	5,3	1,9	10,0	16,0	-	1,5	100	o. r.	o. r.	o. r.
907309	HELU-S-RK-CU 1,5-6	1,5	6,4	1,9	11,0	18,0	-	1,7	100	o. r.	o. r.	o. r.
907310	HELU-S-RK-CU 2,5-4	2,5	4,3	2,4	8,5	15,0	-	1,6	100	o. r.	o. r.	o. r.
907311	HELU-S-RK-CU 2,5-5	2,5	5,3	2,4	10,0	16,0	-	1,8	100	o. r.	o. r.	o. r.
907312	HELU-S-RK-CU 2,5-6	2,5	6,4	2,4	11,0	18,0	-	1,9	100	o. r.	o. r.	o. r.
907313	HELU-S-RK-CU 2,5-8	2,5	8,4	2,4	13,0	20,0	-	2,2	100	o. r.	o. r.	o. r.
907314	HELU-S-RK-CU 4-4	4,0	4,3	3,0	8,5	17,0	-	2,2	100	o. r.	o. r.	o. r.
907315	HELU-S-RK-CU 4-5	4,0	5,3	3,0	10,0	18,0	-	2,4	100	o. r.	o. r.	o. r.
907316	HELU-S-RK-CU 4-6	4,0	6,3	3,0	11,0	20,0	-	2,6	100	o. r.	o. r.	o. r.
907317	HELU-S-RK-CU 4-8	4,0	8,4	3,0	14,0	22,0	-	3,0	100	o. r.	o. r.	o. r.

Dimensions and specifications may be changed without prior notice.

o. r. = on request

HELU-S-RK-CU-UL Copper tubular cable lug - straight



Tubular cable lug HELU-S-RK-CU-UL

Uninsulated, straight tubular cable lugs in eye type design.

Material

Socket: Copper according to DIN EN 13600
Surface: tin plated

Note

Also available in angulated version (45° and 90°).

Technical data

Temperature range: up to +120°C

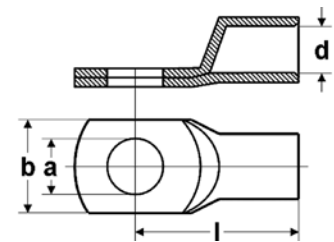

Abmessungen

- a Diameter of the boring
- d Inner diameter of the cable insertion
- b Flange width
- l Length till middle of the boring

Part no.	Type	Cross-section mm ²	a mm	d mm	b mm	l mm	Code type	Weight kg / 1000 items	Unit	Net EUR/100 items at a purchase of		
										up to 100	101 - 500	501 - 1000
907318	HELU-S-RK-CU-UL 6-4	6,0	4,3	3,5	10,0	19,0	-	4,6	100	o. r.	o. r.	o. r.
907319	HELU-S-RK-CU-UL 6-5	6,0	5,3	3,5	10,0	20,0	-	4,7	100	o. r.	o. r.	o. r.
907320	HELU-S-RK-CU-UL 6-6	6,0	6,4	3,5	11,0	21,5	-	5,4	100	o. r.	o. r.	o. r.
907321	HELU-S-RK-CU-UL 6-8	6,0	8,4	3,5	15,0	24,0	-	5,9	100	o. r.	o. r.	o. r.
907322	HELU-S-RK-CU-UL 6-10	6,0	10,5	3,5	18,0	26,0	-	6,4	100	o. r.	o. r.	o. r.
907323	HELU-S-RK-CU-UL 6-12	6,0	13,0	3,5	19,0	27,5	-	6,4	100	o. r.	o. r.	o. r.
907324	HELU-S-RK-CU-UL 10-4	10,0	4,3	4,5	12,0	20,0	-	4,3	100	o. r.	o. r.	o. r.
907325	HELU-S-RK-CU-UL 10-5	10,0	5,3	4,5	12,0	21,0	-	4,8	100	o. r.	o. r.	o. r.
907326	HELU-S-RK-CU-UL 10-6	10,0	6,4	4,5	12,0	22,5	-	5,1	100	o. r.	o. r.	o. r.
907327	HELU-S-RK-CU-UL 10-8	10,0	8,4	4,5	15,0	25,0	-	5,8	100	o. r.	o. r.	o. r.
907328	HELU-S-RK-CU-UL 10-10	10,0	10,5	4,4	18,0	27,0	-	6,3	100	o. r.	o. r.	o. r.
907329	HELU-S-RK-CU-UL 10-12	10,0	13,0	4,5	20,0	28,5	-	6,3	100	o. r.	o. r.	o. r.
907330	HELU-S-RK-CU-UL 16-4	16,0	4,3	5,5	12,0	24,0	-	8,2	100	o. r.	o. r.	o. r.
907331	HELU-S-RK-CU-UL 16-5	16,0	5,3	5,5	12,0	25,0	-	8,9	100	o. r.	o. r.	o. r.
907332	HELU-S-RK-CU-UL 16-6	16,0	6,4	5,5	12,0	26,5	-	9,6	100	o. r.	o. r.	o. r.
907333	HELU-S-RK-CU-UL 16-8	16,0	8,4	5,5	15,0	29,0	-	10,3	100	o. r.	o. r.	o. r.
907334	HELU-S-RK-CU-UL 16-10	16,0	10,5	5,5	18,0	31,0	-	11,0	100	o. r.	o. r.	o. r.
907335	HELU-S-RK-CU-UL 16-12	16,0	13,0	5,5	19,0	32,0	-	10,8	100	o. r.	o. r.	o. r.
907336	HELU-S-RK-CU-UL 25-5	25,0	5,3	7,0	15,0	33,5	-	13,5	100	o. r.	o. r.	o. r.
907337	HELU-S-RK-CU-UL 25-6	25,0	6,4	7,0	15,0	31,5	-	13,1	100	o. r.	o. r.	o. r.
907338	HELU-S-RK-CU-UL 25-8	25,0	8,4	7,0	16,0	33,0	-	12,9	100	o. r.	o. r.	o. r.
907339	HELU-S-RK-CU-UL 25-10	25,0	10,5	7,0	18,0	34,5	-	14,6	100	o. r.	o. r.	o. r.
907340	HELU-S-RK-CU-UL 25-12	25,0	13,0	7,0	20,0	36,0	-	15,5	100	o. r.	o. r.	o. r.
907341	HELU-S-RK-CU-UL 25-14	25,0	15,0	7,0	22,0	39,0	-	16,6	100	o. r.	o. r.	o. r.
907342	HELU-S-RK-CU-UL 25-16	25,0	17,0	7,0	24,0	42,0	-	17,3	100	o. r.	o. r.	o. r.
907343	HELU-S-RK-CU-UL 35-6	35,0	6,4	8,5	17,0	33,0	-	20,7	100	o. r.	o. r.	o. r.
907344	HELU-S-RK-CU-UL 35-8	35,0	8,4	8,5	17,0	34,0	-	21,8	100	o. r.	o. r.	o. r.
907345	HELU-S-RK-CU-UL 35-10	35,0	10,5	8,5	20,0	36,5	-	21,9	100	o. r.	o. r.	o. r.
907346	HELU-S-RK-CU-UL 35-12	35,0	13,0	8,5	22,0	37,5	-	23,3	100	o. r.	o. r.	o. r.
907347	HELU-S-RK-CU-UL 35-14	35,0	15,0	8,5	23,0	40,0	-	24,4	100	o. r.	o. r.	o. r.
907348	HELU-S-RK-CU-UL 35-16	35,0	17,0	8,5	28,0	44,0	-	26,0	100	o. r.	o. r.	o. r.
907349	HELU-S-RK-CU-UL 50-6	50,0	6,4	10,0	20,0	37,0	-	30,1	100	o. r.	o. r.	o. r.
907350	HELU-S-RK-CU-UL 50-8	50,0	8,4	10,0	20,0	39,0	-	30,4	100	o. r.	o. r.	o. r.
907351	HELU-S-RK-CU-UL 50-10	50,0	10,5	10,0	20,0	40,5	-	31,3	100	o. r.	o. r.	o. r.
907352	HELU-S-RK-CU-UL 50-12	50,0	13,0	10,0	23,0	42,0	-	31,3	100	o. r.	o. r.	o. r.
907353	HELU-S-RK-CU-UL 50-14	50,0	15,0	10,0	23,0	44,0	-	35,1	100	o. r.	o. r.	o. r.

Continuation ▶

HELU-S-RK-CU-UL Copper tubular cable lug - straight



Part no.	Type	Cross-section mm ²	a mm	d mm	b mm	l mm	Code type	Weight kg / 1000 items	Unit	Net EUR/100 items at a purchase of		
										up to 100	101 - 500	501 - 1000
907354	HELU-S-RK-CU-UL 50-16	50,0	17,0	10,0	27,0	46,0	-	35,5	100	o. r.	o. r.	o. r.
907355	HELU-S-RK-CU-UL 50-20	50,0	21,0	10,0	30,5	52,5	-	38,9	100	o. r.	o. r.	o. r.
907356	HELU-S-RK-CU-UL 70-6	70,0	6,4	12,0	24,0	40,5	-	41,1	25	o. r.	o. r.	o. r.
907357	HELU-S-RK-CU-UL 70-8	70,0	8,4	12,0	24,0	42,5	-	44,6	25	o. r.	o. r.	o. r.
907358	HELU-S-RK-CU-UL 70-10	70,0	10,5	12,0	24,0	43,5	-	46,4	25	o. r.	o. r.	o. r.
907359	HELU-S-RK-CU-UL 70-12	70,0	13,0	12,0	24,0	45,0	-	47,3	25	o. r.	o. r.	o. r.
907360	HELU-S-RK-CU-UL 70-14	70,0	15,0	12,0	25,0	46,0	-	49,1	25	o. r.	o. r.	o. r.
907361	HELU-S-RK-CU-UL 70-16	70,0	17,0	12,0	28,0	48,5	-	49,6	25	o. r.	o. r.	o. r.
907362	HELU-S-RK-CU-UL 70-20	70,0	21,0	12,0	29,0	52,0	-	52,9	25	o. r.	o. r.	o. r.
907363	HELU-S-RK-CU-UL 95-6	95,0	6,4	13,5	26,0	43,0	-	49,5	25	o. r.	o. r.	o. r.
907364	HELU-S-RK-CU-UL 95-8	95,0	8,4	13,5	26,0	46,0	-	53,6	25	o. r.	o. r.	o. r.
907365	HELU-S-RK-CU-UL 95-10	95,0	10,5	13,5	26,0	47,0	-	55,1	25	o. r.	o. r.	o. r.
907366	HELU-S-RK-CU-UL 95-12	95,0	13,0	13,5	26,0	48,0	-	55,1	25	o. r.	o. r.	o. r.
907367	HELU-S-RK-CU-UL 95-14	95,0	15,0	13,5	26,0	51,5	-	58,9	25	o. r.	o. r.	o. r.
907368	HELU-S-RK-CU-UL 95-16	95,0	17,0	13,5	28,0	51,0	-	58,5	25	o. r.	o. r.	o. r.
907369	HELU-S-RK-CU-UL 95-20	95,0	21,0	13,5	30,0	55,0	-	61,3	25	o. r.	o. r.	o. r.
907370	HELU-S-RK-CU-UL 120-8	120,0	8,4	15,0	29,0	49,5	-	68,8	25	o. r.	o. r.	o. r.
907371	HELU-S-RK-CU-UL 120-10	120,0	10,5	15,0	29,0	52,0	-	79,9	25	o. r.	o. r.	o. r.
907372	HELU-S-RK-CU-UL 120-12	120,0	13,0	15,0	29,0	51,5	-	78,4	25	o. r.	o. r.	o. r.
907373	HELU-S-RK-CU-UL 120-14	120,0	15,0	15,0	30,0	53,0	-	78,6	25	o. r.	o. r.	o. r.
907374	HELU-S-RK-CU-UL 120-16	120,0	17,0	15,0	30,0	55,0	-	80,7	25	o. r.	o. r.	o. r.
907375	HELU-S-RK-CU-UL 120-20	120,0	21,0	15,0	35,0	60,0	-	89,0	25	o. r.	o. r.	o. r.
907376	HELU-S-RK-CU-UL 150-8	150,0	8,4	16,8	31,0	55,5	-	78,9	25	o. r.	o. r.	o. r.
907377	HELU-S-RK-CU-UL 150-10	150,0	10,5	16,8	31,0	56,5	-	83,7	25	o. r.	o. r.	o. r.
907378	HELU-S-RK-CU-UL 150-12	150,0	13,0	16,8	31,0	56,0	-	80,7	25	o. r.	o. r.	o. r.
907379	HELU-S-RK-CU-UL 150-14	150,0	15,0	16,8	31,0	57,0	-	83,0	25	o. r.	o. r.	o. r.
907380	HELU-S-RK-CU-UL 150-16	150,0	17,0	16,8	31,0	58,0	-	83,6	25	o. r.	o. r.	o. r.
907381	HELU-S-RK-CU-UL 150-20	150,0	21,0	16,8	35,0	63,0	-	87,5	25	o. r.	o. r.	o. r.
907382	HELU-S-RK-CU-UL 185-8	185,0	8,4	19,0	35,0	58,0	-	103,7	25	o. r.	o. r.	o. r.
907383	HELU-S-RK-CU-UL 185-10	185,0	10,5	19,0	35,0	59,0	-	106,1	25	o. r.	o. r.	o. r.
907384	HELU-S-RK-CU-UL 185-12	185,0	13,0	19,0	35,0	58,5	-	106,0	25	o. r.	o. r.	o. r.
907385	HELU-S-RK-CU-UL 185-14	185,0	15,0	19,0	35,0	61,0	-	107,2	25	o. r.	o. r.	o. r.
907386	HELU-S-RK-CU-UL 185-16	185,0	17,0	19,0	35,0	63,0	-	108,6	25	o. r.	o. r.	o. r.
907387	HELU-S-RK-CU-UL 185-20	185,0	21,0	19,0	35,0	66,0	-	113,3	25	o. r.	o. r.	o. r.
907388	HELU-S-RK-CU-UL 240-8	240,0	8,4	21,0	38,0	67,0	-	124,0	25	o. r.	o. r.	o. r.
907389	HELU-S-RK-CU-UL 240-10	240,0	10,5	21,0	38,0	67,0	-	129,7	25	o. r.	o. r.	o. r.
907390	HELU-S-RK-CU-UL 240-12	240,0	13,0	21,0	38,0	67,0	-	130,2	25	o. r.	o. r.	o. r.
907391	HELU-S-RK-CU-UL 240-14	240,0	15,0	21,0	38,0	69,0	-	133,6	25	o. r.	o. r.	o. r.
907392	HELU-S-RK-CU-UL 240-16	240,0	17,0	21,0	38,0	69,5	-	135,6	20	o. r.	o. r.	o. r.
907393	HELU-S-RK-CU-UL 240-20	240,0	21,0	21,0	38,0	71,0	-	138,0	25	o. r.	o. r.	o. r.
907394	HELU-S-RK-CU-UL 300-10	300,0	10,5	24,0	44,0	79,5	-	204,5	20	o. r.	o. r.	o. r.
907395	HELU-S-RK-CU-UL 300-12	300,0	13,0	24,0	44,0	82,0	-	211,8	20	o. r.	o. r.	o. r.
907396	HELU-S-RK-CU-UL 300-14	300,0	15,0	24,0	44,0	84,0	-	221,9	20	o. r.	o. r.	o. r.
907397	HELU-S-RK-CU-UL 300-16	300,0	17,0	24,0	44,0	85,0	-	219,4	20	o. r.	o. r.	o. r.
907398	HELU-S-RK-CU-UL 300-20	300,0	21,0	24,0	44,0	85,0	-	224,0	20	o. r.	o. r.	o. r.
907399	HELU-S-RK-CU-UL 400-10	400,0	10,5	27,5	49,0	92,0	-	279,0	15	o. r.	o. r.	o. r.
907400	HELU-S-RK-CU-UL 400-12	400,0	13,0	27,5	49,0	92,0	-	278,5	15	o. r.	o. r.	o. r.
907401	HELU-S-RK-CU-UL 400-16	400,0	17,0	27,5	49,0	92,0	-	276,5	15	o. r.	o. r.	o. r.
907402	HELU-S-RK-CU-UL 400-20	400,0	21,0	27,5	49,0	92,0	-	266,1	15	o. r.	o. r.	o. r.
907403	HELU-S-RK-CU-UL 500-12	500,0	13,0	31,0	55,5	113,0	-	493,8	5	o. r.	o. r.	o. r.
907404	HELU-S-RK-CU-UL 500-16	500,0	17,0	31,0	55,5	113,0	-	493,8	5	o. r.	o. r.	o. r.
907405	HELU-S-RK-CU-UL 500-20	500,0	21,0	31,0	55,5	113,0	-	485,6	5	o. r.	o. r.	o. r.
907406	HELU-S-RK-CU-UL 630-16	630,0	17,0	34,0	60,0	115,0	-	513,5	5	o. r.	o. r.	o. r.
907407	HELU-S-RK-CU-UL 630-20	630,0	21,0	34,0	60,0	115,0	-	506,0	5	o. r.	o. r.	o. r.

Dimensions and specifications may be changed without prior notice.

o. r. = on request

HELU-S-RK-45-CU-UL Copper tubular cable lug - 45° angled



Tubular cable lug angled HELU-S-RK-45-CU-UL

Non-insulated tubular cable lugs in eye type design, 45° angled.

Material

Socket: Copper according to DIN EN 13600
Surface: tin plated

Technical data

Temperature range: up to +120°C

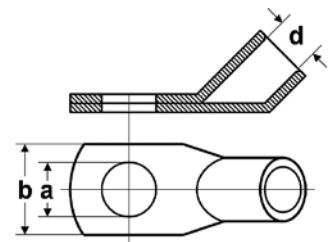

Dimensions

- a Diameter of the boring
- d Inner diameter of the cable insertion
- b Flange width

Part no. 45°	Type	Cross-section mm ²	a mm	d mm	b mm	Weight kg / 1000 items	Unit	Net EUR/ 100 items at a purchase of		
								up to 100	101 - 500	501 - 1000
907597	HELU-S-RK-45-CU-UL 10-5	10,0	5,3	4,5	12,0	5,5	100	o. r.	o. r.	o. r.
907598	HELU-S-RK-45-CU-UL 10-6	10,0	6,4	4,5	12,0	5,8	100	o. r.	o. r.	o. r.
907599	HELU-S-RK-45-CU-UL 10-8	10,0	8,4	4,5	15,0	6,5	100	o. r.	o. r.	o. r.
907601	HELU-S-RK-45-CU-UL 16-5	16,0	5,3	5,5	12,0	9,5	100	o. r.	o. r.	o. r.
907467	HELU-S-RK-45-CU-UL 16-6	16,0	6,4	5,5	12,0	10,2	100	o. r.	o. r.	o. r.
907468	HELU-S-RK-45-CU-UL 16-8	16,0	8,4	5,5	15,0	11,7	100	o. r.	o. r.	o. r.
907469	HELU-S-RK-45-CU-UL 16-10	16,0	10,5	5,5	18,0	11,7	100	o. r.	o. r.	o. r.
907470	HELU-S-RK-45-CU-UL 25-6	25,0	6,4	7,0	15,0	13,9	100	o. r.	o. r.	o. r.
907471	HELU-S-RK-45-CU-UL 25-8	25,0	8,4	7,0	16,0	15,1	100	o. r.	o. r.	o. r.
907472	HELU-S-RK-45-CU-UL 25-10	25,0	10,5	7,0	18,0	16,6	100	o. r.	o. r.	o. r.
907473	HELU-S-RK-45-CU-UL 25-12	25,0	13,0	7,0	20,0	17,0	100	o. r.	o. r.	o. r.
907474	HELU-S-RK-45-CU-UL 35-6	35,0	6,4	8,5	17,0	21,7	50	o. r.	o. r.	o. r.
907475	HELU-S-RK-45-CU-UL 35-8	35,0	8,4	8,5	17,0	22,3	50	o. r.	o. r.	o. r.
907476	HELU-S-RK-45-CU-UL 35-10	35,0	10,5	8,5	20,0	23,4	50	o. r.	o. r.	o. r.
907477	HELU-S-RK-45-CU-UL 35-12	35,0	13,0	8,5	22,0	24,0	50	o. r.	o. r.	o. r.
907479	HELU-S-RK-45-CU-UL 50-8	50,0	8,4	10,0	20,0	33,4	50	o. r.	o. r.	o. r.
907480	HELU-S-RK-45-CU-UL 50-10	50,0	10,5	10,0	20,0	36,5	50	o. r.	o. r.	o. r.
907481	HELU-S-RK-45-CU-UL 50-12	50,0	13,0	10,0	23,0	36,5	50	o. r.	o. r.	o. r.
907482	HELU-S-RK-45-CU-UL 70-8	70,0	8,4	12,0	24,0	49,0	25	o. r.	o. r.	o. r.
907483	HELU-S-RK-45-CU-UL 70-10	70,0	10,5	12,0	24,0	52,3	25	o. r.	o. r.	o. r.
907484	HELU-S-RK-45-CU-UL 70-12	70,0	13,0	12,0	24,0	53,4	25	o. r.	o. r.	o. r.
907485	HELU-S-RK-45-CU-UL 95-8	95,0	8,4	13,5	26,0	61,8	25	o. r.	o. r.	o. r.
907486	HELU-S-RK-45-CU-UL 95-10	95,0	10,5	13,5	26,0	62,0	25	o. r.	o. r.	o. r.
907487	HELU-S-RK-45-CU-UL 95-12	95,0	13,0	13,5	26,0	62,0	25	o. r.	o. r.	o. r.
907489	HELU-S-RK-45-CU-UL 120-8	120,0	8,4	15,0	29,0	78,0	25	o. r.	o. r.	o. r.
907490	HELU-S-RK-45-CU-UL 120-10	120,0	10,5	15,0	29,0	89,0	25	o. r.	o. r.	o. r.
907491	HELU-S-RK-45-CU-UL 120-12	120,0	13,0	15,0	29,0	89,1	25	o. r.	o. r.	o. r.
907492	HELU-S-RK-45-CU-UL 120-16	120,0	17,0	15,0	30,0	93,1	25	o. r.	o. r.	o. r.
907494	HELU-S-RK-45-CU-UL 150-10	150,0	10,5	16,8	31,0	98,0	25	o. r.	o. r.	o. r.
907495	HELU-S-RK-45-CU-UL 150-12	150,0	13,0	16,8	31,0	96,8	25	o. r.	o. r.	o. r.
907496	HELU-S-RK-45-CU-UL 150-16	150,0	17,0	16,8	31,0	101,2	25	o. r.	o. r.	o. r.
907498	HELU-S-RK-45-CU-UL 185-10	185,0	10,5	19,0	35,0	123,5	20	o. r.	o. r.	o. r.
907499	HELU-S-RK-45-CU-UL 185-12	185,0	13,0	19,0	35,0	122,4	20	o. r.	o. r.	o. r.
907500	HELU-S-RK-45-CU-UL 185-16	185,0	17,0	19,0	35,0	128,4	20	o. r.	o. r.	o. r.
907501	HELU-S-RK-45-CU-UL 185-20	185,0	21,0	19,0	35,0	139,9	20	o. r.	o. r.	o. r.
907502	HELU-S-RK-45-CU-UL 240-12	240,0	13,0	21,0	38,0	154,6	15	o. r.	o. r.	o. r.
907503	HELU-S-RK-45-CU-UL 240-16	240,0	17,0	21,0	38,0	165,1	15	o. r.	o. r.	o. r.
907504	HELU-S-RK-45-CU-UL 240-20	240,0	21,0	21,0	38,0	170,4	15	o. r.	o. r.	o. r.

Dimensions and specifications may be changed without prior notice.

HELU-S-RK-45-CU Copper tubular cable lug - 45° angled



Tubular cable lug angled HELU-S-RK-45-CU

Non-insulated tubular cable lugs in eye type design, 45° angled.

Material

Socket: Copper according to DIN EN 13600
Surface: tin plated

Technical data

Temperature range: up to +120°C

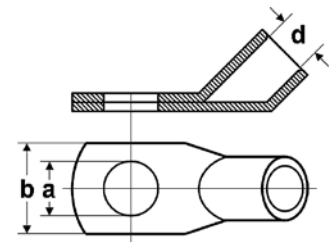

Dimensions

- a Diameter of the boring
- d Inner diameter of the cable insertion
- b Flange width

Part no. 45°	Type	Cross-section mm ²	a mm	d mm	b mm	Weight kg / 1000 items	Unit	Net EUR/100 items at a purchase of		
								up to 100	101 - 500	501 - 1000
907600	HELU-S-RK-45-CU 10-10	10,0	10,5	4,5	18,0	6,6	100	o. r.	o. r.	o. r.
907478	HELU-S-RK-45-CU 50-6	50,0	6,4	10,0	20,0	29,4	50	o. r.	o. r.	o. r.
907488	HELU-S-RK-45-CU 95-16	95,0	17,0	13,5	28,0	68,0	25	o. r.	o. r.	o. r.
907493	HELU-S-RK-45-CU 150-8	150,0	8,4	16,8	31,0	113,1	25	o. r.	o. r.	o. r.
907497	HELU-S-RK-45-CU 150-20	150,0	21,0	16,8	35,0	101,2	25	o. r.	o. r.	o. r.
907505	HELU-S-RK-45-CU 300-12	300,0	13,0	24,0	43,0	257,0	15	o. r.	o. r.	o. r.
907506	HELU-S-RK-45-CU 300-16	300,0	17,0	24,0	43,0	256,8	15	o. r.	o. r.	o. r.
907507	HELU-S-RK-45-CU 300-20	300,0	21,0	24,0	43,0	273,0	15	o. r.	o. r.	o. r.

Dimensions and specifications may be changed without prior notice.

o. r. = on request

HELU-S-RK-90-CU-UL Copper tubular cable lug - 90° angled



Tubular cable lug angled HELU-S-RK-90-CU-UL

Non-insulated tubular cable lugs in eye type design, 90° angled.

Material

Socket: Copper according to DIN EN 13600
Surface: tin plated

Technical data

Temperature range: up to +120°C

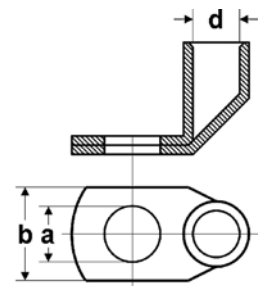

Dimensions

- a Diameter of boring
- d Inner diameter of the cable insertion
- b Flange width

Part no. 90°	Type	Cross-section mm ²	a mm	d mm	b mm	Weight kg / 1000 items	Unit	Net EUR/ 100 items at a purchase of		
								up to 100	101 - 500	501 - 1000
907508	HELU-S-RK-90-CU-UL 6-5	6,0	5,3	3,5	11,0	5,6	100	o. r.	o. r.	o. r.
907509	HELU-S-RK-90-CU-UL 6-6	6,0	6,4	3,5	11,0	6,2	100	o. r.	o. r.	o. r.
907510	HELU-S-RK-90-CU-UL 6-8	6,0	8,4	3,5	15,0	6,4	100	o. r.	o. r.	o. r.
907511	HELU-S-RK-90-CU-UL 6-10	6,0	10,5	3,5	18,0	6,8	100	o. r.	o. r.	o. r.
907512	HELU-S-RK-90-CU-UL 6-12	6,0	13,0	3,5	20,0	6,6	100	o. r.	o. r.	o. r.
907513	HELU-S-RK-90-CU-UL 10-5	10,0	5,3	4,5	12,0	5,4	100	o. r.	o. r.	o. r.
907514	HELU-S-RK-90-CU-UL 10-6	10,0	6,4	4,5	12,0	5,9	100	o. r.	o. r.	o. r.
907515	HELU-S-RK-90-CU-UL 10-8	10,0	8,4	4,5	15,0	6,7	100	o. r.	o. r.	o. r.
907516	HELU-S-RK-90-CU-UL 10-10	10,0	10,5	4,5	18,0	7,0	100	o. r.	o. r.	o. r.
907517	HELU-S-RK-90-CU-UL 10-12	10,0	13,0	4,5	20,0	7,0	100	o. r.	o. r.	o. r.
907518	HELU-S-RK-90-CU-UL 16-5	16,0	5,3	5,5	12,0	10,7	100	o. r.	o. r.	o. r.
907519	HELU-S-RK-90-CU-UL 16-6	16,0	6,4	5,5	12,0	11,5	100	o. r.	o. r.	o. r.
907520	HELU-S-RK-90-CU-UL 16-8	16,0	8,4	5,5	15,0	12,0	100	o. r.	o. r.	o. r.
907521	HELU-S-RK-90-CU-UL 16-10	16,0	10,5	5,5	18,0	12,3	100	o. r.	o. r.	o. r.
907522	HELU-S-RK-90-CU-UL 16-12	16,0	13,0	5,5	20,0	12,3	100	o. r.	o. r.	o. r.
907523	HELU-S-RK-90-CU-UL 25-6	25,0	6,4	7,0	15,0	13,5	100	o. r.	o. r.	o. r.
907524	HELU-S-RK-90-CU-UL 25-8	25,0	8,4	7,0	16,0	14,3	100	o. r.	o. r.	o. r.
907525	HELU-S-RK-90-CU-UL 25-10	25,0	10,5	7,0	18,0	15,7	100	o. r.	o. r.	o. r.
907526	HELU-S-RK-90-CU-UL 25-12	25,0	13,0	7,0	20,0	15,1	100	o. r.	o. r.	o. r.
907527	HELU-S-RK-90-CU-UL 35-6	35,0	6,4	8,5	17,0	21,0	100	o. r.	o. r.	o. r.
907528	HELU-S-RK-90-CU-UL 35-8	35,0	8,4	8,5	17,0	23,1	100	o. r.	o. r.	o. r.
907529	HELU-S-RK-90-CU-UL 35-10	35,0	10,5	8,5	20,0	23,6	100	o. r.	o. r.	o. r.
907530	HELU-S-RK-90-CU-UL 35-12	35,0	13,0	8,5	22,0	23,7	100	o. r.	o. r.	o. r.
907531	HELU-S-RK-90-CU-UL 35-16	35,0	17,0	8,5	28,0	24,8	100	o. r.	o. r.	o. r.
907532	HELU-S-RK-90-CU-UL 50-6	50,0	6,4	10,0	20,0	30,0	100	o. r.	o. r.	o. r.
907533	HELU-S-RK-90-CU-UL 50-8	50,0	8,4	10,0	20,0	32,2	100	o. r.	o. r.	o. r.
907534	HELU-S-RK-90-CU-UL 50-10	50,0	10,5	10,0	20,0	33,2	100	o. r.	o. r.	o. r.
907535	HELU-S-RK-90-CU-UL 50-12	50,0	13,0	10,0	23,0	32,8	100	o. r.	o. r.	o. r.
907536	HELU-S-RK-90-CU-UL 50-16	50,0	17,0	10,0	27,0	36,3	100	o. r.	o. r.	o. r.
907537	HELU-S-RK-90-CU-UL 50-20	50,0	21,0	10,0	30,0	38,9	100	o. r.	o. r.	o. r.
907538	HELU-S-RK-90-CU-UL 70-6	70,0	6,4	12,0	24,0	44,1	25	o. r.	o. r.	o. r.
907539	HELU-S-RK-90-CU-UL 70-8	70,0	8,4	12,0	24,0	48,6	25	o. r.	o. r.	o. r.
907540	HELU-S-RK-90-CU-UL 70-10	70,0	10,5	12,0	24,0	50,6	25	o. r.	o. r.	o. r.
907541	HELU-S-RK-90-CU-UL 70-12	70,0	13,0	12,0	24,0	49,4	25	o. r.	o. r.	o. r.
907542	HELU-S-RK-90-CU-UL 70-16	70,0	17,0	12,0	28,0	51,1	25	o. r.	o. r.	o. r.
907543	HELU-S-RK-90-CU-UL 70-20	70,0	21,0	12,0	29,0	52,6	25	o. r.	o. r.	o. r.

HELU-S-RK-90-CU-UL Copper tubular cable lug - 90° angled



Part no. 90°	Type	Cross-section mm ²	a mm	d mm	b mm	Weight kg / 1000 items	Unit	Net EUR/100 items at a purchase of		
								up to 100	101 - 500	501 - 1000
907544	HELU-S-RK-90-CU-UL 95-8	95,0	8,4	13,5	26,0	53,3	25	o. r.	o. r.	o. r.
907545	HELU-S-RK-90-CU-UL 95-10	95,0	10,5	13,5	26,0	55,9	25	o. r.	o. r.	o. r.
907546	HELU-S-RK-90-CU-UL 95-12	95,0	13,0	13,5	26,0	56,6	25	o. r.	o. r.	o. r.
907547	HELU-S-RK-90-CU-UL 95-16	95,0	17,0	13,5	28,0	60,0	25	o. r.	o. r.	o. r.
907548	HELU-S-RK-90-CU-UL 120-8	120,0	8,4	15,0	29,0	76,3	25	o. r.	o. r.	o. r.
907549	HELU-S-RK-90-CU-UL 120-10	120,0	10,5	15,0	29,0	80,7	25	o. r.	o. r.	o. r.
907550	HELU-S-RK-90-CU-UL 120-12	120,0	13,0	15,0	29,0	79,9	25	o. r.	o. r.	o. r.
907551	HELU-S-RK-90-CU-UL 120-16	120,0	17,0	15,0	30,0	84,6	25	o. r.	o. r.	o. r.
907552	HELU-S-RK-90-CU-UL 150-8	150,0	8,4	16,8	31,0	80,3	25	o. r.	o. r.	o. r.
907553	HELU-S-RK-90-CU-UL 150-10	150,0	10,5	16,8	31,0	80,7	25	o. r.	o. r.	o. r.
907554	HELU-S-RK-90-CU-UL 150-12	150,0	13,0	16,8	31,0	82,9	25	o. r.	o. r.	o. r.
907555	HELU-S-RK-90-CU-UL 150-16	150,0	17,0	16,8	31,0	85,0	25	o. r.	o. r.	o. r.
907556	HELU-S-RK-90-CU-UL 150-20	150,0	21,0	16,8	35,0	88,9	25	o. r.	o. r.	o. r.
907557	HELU-S-RK-90-CU-UL 185-10	185,0	10,5	19,0	35,0	114,1	25	o. r.	o. r.	o. r.
907558	HELU-S-RK-90-CU-UL 185-12	185,0	13,0	19,0	35,0	120,4	25	o. r.	o. r.	o. r.
907559	HELU-S-RK-90-CU-UL 185-16	185,0	17,0	19,0	35,0	124,8	25	o. r.	o. r.	o. r.
907560	HELU-S-RK-90-CU-UL 185-20	185,0	21,0	19,0	35,0	127,0	25	o. r.	o. r.	o. r.
907561	HELU-S-RK-90-CU-UL 240-10	240,0	10,5	21,0	38,0	133,2	25	o. r.	o. r.	o. r.
907562	HELU-S-RK-90-CU-UL 240-12	240,0	13,0	21,0	38,0	134,0	25	o. r.	o. r.	o. r.
907563	HELU-S-RK-90-CU-UL 240-16	240,0	17,0	21,0	38,0	137,6	25	o. r.	o. r.	o. r.
907564	HELU-S-RK-90-CU-UL 240-20	240,0	21,0	21,0	38,0	142,3	25	o. r.	o. r.	o. r.
907565	HELU-S-RK-90-CU-UL 300-12	300,0	13,0	24,0	43,0	199,2	20	o. r.	o. r.	o. r.
907566	HELU-S-RK-90-CU-UL 300-16	300,0	17,0	24,0	43,0	209,0	20	o. r.	o. r.	o. r.
907567	HELU-S-RK-90-CU-UL 300-20	300,0	21,0	24,0	43,0	218,1	20	o. r.	o. r.	o. r.

Dimensions and specifications may be changed without prior notice.

o. r. = on request

HELU-S-RK-S-CU-UL Tubular cable lug - straight - small flange



Tubular cable lug HELU-S-RK-S-CU-UL

Non-insulated tubular cable lugs in eye type design with small flange.
For screwing in switch cabinets with reduced connecting space.

Material

Socket: Copper
Surface: tinned

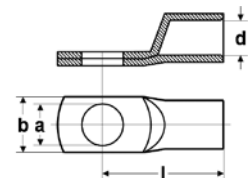

Dimensions

- a Diameter of the boring
- d Inner diameter of the cable insertion
- b Flange width
- l Length till middle of the boring

Part no. straight	Type	Cross-section mm ²	a mm	d mm	b mm	Weight kg / 1000 items	Unit	Net EUR/ 100 items at a purchase of		
								up to 100	101 - 500	501 - 1000
90910	HELU-S-RK-S-CU-UL 35-6	35,0	6,5	8,5	15,0	17,8	25	o. r.	o. r.	o. r.
90911	HELU-S-RK-S-CU-UL 50-6	50,0	6,5	10,0	15,0	29,5	25	o. r.	o. r.	o. r.
90912	HELU-S-RK-S-CU-UL 50-8	50,0	8,5	10,0	17,0	28,2	25	o. r.	o. r.	o. r.
90913	HELU-S-RK-S-CU-UL 50-10	50,0	10,5	10,0	19,0	30,8	25	o. r.	o. r.	o. r.
90914	HELU-S-RK-S-CU-UL 70-6	70,0	6,5	12,0	17,0	42,2	25	o. r.	o. r.	o. r.
90915	HELU-S-RK-S-CU-UL 70-8	70,0	8,5	12,0	17,0	41,0	25	o. r.	o. r.	o. r.
90916	HELU-S-RK-S-CU-UL 70-10	70,0	10,5	12,0	19,0	44,5	25	o. r.	o. r.	o. r.
90917	HELU-S-RK-S-CU-UL 70-12	70,0	13,0	12,0	19,0	42,2	25	o. r.	o. r.	o. r.
90918	HELU-S-RK-S-CU-UL 95-6	95,0	6,5	13,5	19,0	54,9	25	o. r.	o. r.	o. r.
90919	HELU-S-RK-S-CU-UL 95-8	95,0	8,5	13,5	19,0	54,6	25	o. r.	o. r.	o. r.
90920	HELU-S-RK-S-CU-UL 95-10	95,0	10,5	13,5	19,0	51,3	25	o. r.	o. r.	o. r.
90921	HELU-S-RK-S-CU-UL 95-12	95,0	13,0	13,5	19,0	51,5	25	o. r.	o. r.	o. r.
90922	HELU-S-RK-S-CU-UL 120-6	120,0	6,5	15,0	19,0	61,6	10	o. r.	o. r.	o. r.
90923	HELU-S-RK-S-CU-UL 120-8	120,0	8,5	15,0	19,0	59,4	10	o. r.	o. r.	o. r.
90924	HELU-S-RK-S-CU-UL 120-10	120,0	10,5	15,0	19,0	58,1	10	o. r.	o. r.	o. r.
90925	HELU-S-RK-S-CU-UL 120-12	120,0	13,0	15,0	19,0	59,2	10	o. r.	o. r.	o. r.
90926	HELU-S-RK-S-CU-UL 150-6	150,0	6,5	16,5	19,0	68,5	10	o. r.	o. r.	o. r.
90927	HELU-S-RK-S-CU-UL 150-8	150,0	8,5	16,5	19,0	68,0	10	o. r.	o. r.	o. r.
90928	HELU-S-RK-S-CU-UL 150-10	150,0	10,5	16,5	19,0	67,5	10	o. r.	o. r.	o. r.
90929	HELU-S-RK-S-CU-UL 150-12	150,0	13,0	16,5	19,0	71,5	10	o. r.	o. r.	o. r.
90930	HELU-S-RK-S-CU-UL 185-10	185,0	10,5	19,0	24,5	105,9	10	o. r.	o. r.	o. r.
90931	HELU-S-RK-S-CU-UL 185-12	185,0	13,0	19,0	31,0	110,9	10	o. r.	o. r.	o. r.
90932	HELU-S-RK-S-CU-UL 185-16	185,0	17,0	19,0	31,0	97,6	10	o. r.	o. r.	o. r.
90933	HELU-S-RK-S-CU-UL 240-10	240,0	10,5	21,0	31,0	127,0	5	o. r.	o. r.	o. r.
90934	HELU-S-RK-S-CU-UL 240-12	240,0	13,0	21,0	31,0	137,2	5	o. r.	o. r.	o. r.
90935	HELU-S-RK-S-CU-UL 240-16	240,0	17,0	21,0	31,0	132,8	5	o. r.	o. r.	o. r.

Dimensions and specifications may be changed without prior notice.

o. r. = on request

HELU-S-PK-CU-DIN Copper tubular compression lug - straight



Tubular compression lug HELU-S-PK-CU-DIN

Uninsulated tubular compression lugs in eye type design for tubular arrangement RM, to DIN 46235.

Material

Socket: Copper according to DIN EN 13600
Surface: tin plated

Note

- Code type indicates the required hexagonal clamping insert.

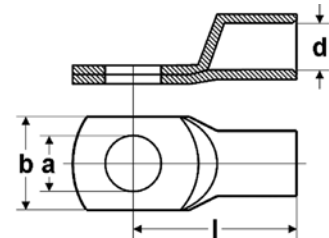

Diameter

- a Diameter of the boring
- d Inner diameter of the cable insertion
- b Flange width
- l Length till middle of the boring

Part no.	Type	Cross-section mm ²	a mm	d mm	b mm	l mm	Code type	Weight kg / 1000 items	Unit	Net EUR/100 items at a purchase of		
										up to 100	101 - 500	501 - 1000
907677	HELU-S-PK-CU-DIN 6-5	6,0	5,3	3,7	8,5	24,0	5	3,1	100	o. r.	o. r.	o. r.
907678	HELU-S-PK-CU-DIN 6-6	6,0	6,4	3,7	3,7	24,0	5	3,4	100	o. r.	o. r.	o. r.
907680	HELU-S-PK-CU-DIN 10-5	10,0	5,3	4,4	10,0	27,0	6	3,5	100	o. r.	o. r.	o. r.
907681	HELU-S-PK-CU-DIN 10-6	10,0	6,4	4,4	10,0	27,0	6	3,7	100	o. r.	o. r.	o. r.
907685	HELU-S-PK-CU-DIN 16-6	16,0	6,4	5,5	13,0	36,0	8	12,7	100	o. r.	o. r.	o. r.
907686	HELU-S-PK-CU-DIN 16-8	16,0	8,4	5,5	13,0	37,0	8	13,0	100	o. r.	o. r.	o. r.
907687	HELU-S-PK-CU-DIN 16-10	16,0	10,5	5,5	16,5	38,0	8	13,2	100	o. r.	o. r.	o. r.
907689	HELU-S-PK-CU-DIN 25-6	25,0	6,4	7,0	14,0	39,0	10	16,2	100	o. r.	o. r.	o. r.
907690	HELU-S-PK-CU-DIN 25-8	25,0	8,4	7,0	17,0	39,0	10	17,3	100	o. r.	o. r.	o. r.
907691	HELU-S-PK-CU-DIN 25-10	25,0	10,5	7,0	17,0	40,5	10	17,7	100	o. r.	o. r.	o. r.
907692	HELU-S-PK-CU-DIN 25-12	25,0	13,0	7,0	18,0	40,5	10	17,2	100	o. r.	o. r.	o. r.
907695	HELU-S-PK-CU-DIN 35-8	35,0	8,4	8,2	18,0	42,0	12	31,9	100	o. r.	o. r.	o. r.
907696	HELU-S-PK-CU-DIN 35-10	35,0	10,5	8,2	20,0	42,5	12	31,7	100	o. r.	o. r.	o. r.
907697	HELU-S-PK-CU-DIN 35-12	35,0	13,0	8,2	21,0	44,0	12	31,1	100	o. r.	o. r.	o. r.
907701	HELU-S-PK-CU-DIN 50-8	50,0	8,4	9,8	20,0	52,0	14	50,0	100	o. r.	o. r.	o. r.
907702	HELU-S-PK-CU-DIN 50-10	50,0	10,5	9,8	22,0	52,0	14	49,4	100	o. r.	o. r.	o. r.
907703	HELU-S-PK-CU-DIN 50-12	50,0	13,0	9,8	23,0	52,0	14	49,1	100	o. r.	o. r.	o. r.
907705	HELU-S-PK-CU-DIN 50-16	50,0	17,0	9,8	28,0	55,5	14	50,4	100	o. r.	o. r.	o. r.
907707	HELU-S-PK-CU-DIN 70-8	70,0	8,4	11,3	24,0	56,0	16	65,4	50	o. r.	o. r.	o. r.
907708	HELU-S-PK-CU-DIN 70-10	70,0	10,5	11,3	24,0	56,0	16	65,4	50	o. r.	o. r.	o. r.
907709	HELU-S-PK-CU-DIN 70-12	70,0	13,0	11,3	24,0	56,5	16	65,7	50	o. r.	o. r.	o. r.
907711	HELU-S-PK-CU-DIN 70-16	70,0	17,0	11,3	29,0	57,0	16	69,2	50	o. r.	o. r.	o. r.
906524	HELU-S-PK-CU-DIN 95-10	95,0	10,5	13,5	28,0	65,5	18	95,5	50	o. r.	o. r.	o. r.
906525	HELU-S-PK-CU-DIN 95-12	95,0	13,0	13,5	28,0	65,5	18	94,5	50	o. r.	o. r.	o. r.
907715	HELU-S-PK-CU-DIN 95-16	95,0	17,0	13,5	30,0	65,5	18	94,4	50	o. r.	o. r.	o. r.
907716	HELU-S-PK-CU-DIN 95-20	95,0	21,0	13,5	33,0	71,0	18	98,6	50	o. r.	o. r.	o. r.
906526	HELU-S-PK-CU-DIN 120-10	120,0	10,5	15,5	31,0	70,0	20	114,0	50	o. r.	o. r.	o. r.
906527	HELU-S-PK-CU-DIN 120-12	120,0	13,0	15,5	31,0	70,5	20	114,3	50	o. r.	o. r.	o. r.
907719	HELU-S-PK-CU-DIN 120-16	120,0	17,0	15,5	31,5	70,0	20	113,6	50	o. r.	o. r.	o. r.
907720	HELU-S-PK-CU-DIN 120-20	120,0	21,0	15,5	36,0	72,0	20	115,1	50	o. r.	o. r.	o. r.
907722	HELU-S-PK-CU-DIN 150-10	150,0	10,5	17,0	34,0	79,0	22	164,6	25	o. r.	o. r.	o. r.
906528	HELU-S-PK-CU-DIN 150-12	150,0	13,0	17,0	34,0	78,5	22	165,3	25	o. r.	o. r.	o. r.
906529	HELU-S-PK-CU-DIN 150-16	150,0	17,0	17,0	34,0	78,0	22	163,5	25	o. r.	o. r.	o. r.
907724	HELU-S-PK-CU-DIN 150-20	150,0	21,0	17,0	38,0	78,0	22	163,4	25	o. r.	o. r.	o. r.
907726	HELU-S-PK-CU-DIN 185-10	185,0	10,5	19,0	37,0	83,0	25	185,0	25	o. r.	o. r.	o. r.
906530	HELU-S-PK-CU-DIN 185-12	185,0	13,0	19,0	37,0	82,5	25	189,5	25	o. r.	o. r.	o. r.
906531	HELU-S-PK-CU-DIN 185-16	185,0	17,0	19,0	37,0	82,0	25	194,1	25	o. r.	o. r.	o. r.
907728	HELU-S-PK-CU-DIN 185-20	185,0	21,0	19,0	40,0	83,0	25	190,1	25	o. r.	o. r.	o. r.
906532	HELU-S-PK-CU-DIN 240-12	240,0	13,0	21,5	42,5	92,0	28	266,5	20	o. r.	o. r.	o. r.
906533	HELU-S-PK-CU-DIN 240-16	240,0	17,0	21,5	42,5	92,0	28	274,5	20	o. r.	o. r.	o. r.

Continuation▶

HELU-S-PK-CU-DIN Copper tubular compression lug - straight

Part no.	Type	Cross-section mm ²	a mm	d mm	b mm	l mm	Code type	Weight kg / 1000 items	Unit	Net EUR/100 items at a purchase of		
										up to 100	101 - 500	501 - 1000
907731	HELU-S-PK-CU-DIN 240-20	240,0	21,0	21,5	45,0	92,0	28	276,7	20	o. r.	o. r.	o. r.
906534	HELU-S-PK-CU-DIN 300-16	300,0	17,0	24,5	48,5	100,0	32	341,6	10	o. r.	o. r.	o. r.
906535	HELU-S-PK-CU-DIN 300-20	300,0	21,0	24,5	48,5	100,0	32	344,6	10	o. r.	o. r.	o. r.
906536	HELU-S-PK-CU-DIN 400-16	400,0	17,0	27,5	55,0	117,0	38	717,5	5	o. r.	o. r.	o. r.
906537	HELU-S-PK-CU-DIN 400-20	400,0	21,0	27,5	55,0	117,0	38	706,4	5	o. r.	o. r.	o. r.
906538	HELU-S-PK-CU-DIN 500-20	500,0	21,0	31,0	60,0	130,0	42	876,6	5	o. r.	o. r.	o. r.
907744	HELU-S-PK-CU-DIN 625-20	625,0	21,0	34,5	63,0	135,0	44	820,5	5	o. r.	o. r.	o. r.
907747	HELU-S-PK-CU-DIN 800-20	800,0	21,0	40,0	75,0	165,0	100	1455,5	2	o. r.	o. r.	o. r.
907749	HELU-S-PK-CU-DIN 1000-20	1000,0	21,0	44,0	83,0	167,0	58	1890,0	2	o. r.	o. r.	o. r.

Dimensions and specifications may be changed without prior notice.

o. r. = on request

HELU-S-PK-AL-DIN Aluminium compression cable lug - straight



Compression cable lug HELU-S-PK-AL-DIN

Uninsulated, straight tubular cable lug in eye type design made of aluminium. High quality version for reliable crimping. Designed for conductor type RM acc. to DIN 48201 and circular reshaped conductors.

Material

AL 99,5
Surface: bare

Note

- Code type indicates the required hexagonal crimping insert.
- Sleeves are prefilled with contact grease and sealed with plastic plug

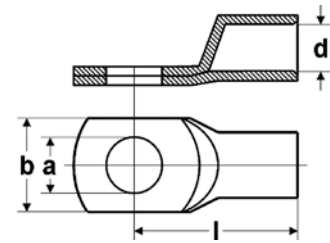

Dimensions

- a Diameter of the bore
- d Inner diameter of the cable inclusion
- b Flange width
- l Length to middle of the bore

Part no.	Type	Cross-section RM/SM - SE mm ²	a mm	d mm	b mm	l mm	Code type	Weight kg / 1000 items	Unit	Net EUR/100 items at a purchase of		
										up to 100	101 - 500	501 - 1000
907865	HELU-S-PK-AL-DIN 16-8	16,0 - 25,0	8,4	5,6	16,0	52,0	12	9,6	50	o. r.	o. r.	o. r.
907866	HELU-S-PK-AL-DIN 16-10	16,0 - 25,0	10,5	5,6	18,0	52,0	12	9,7	50	o. r.	o. r.	o. r.
907867	HELU-S-PK-AL-DIN 25-8	25,0 - 35,0	8,4	6,8	16,0	60,0	12	14,8	50	o. r.	o. r.	o. r.
907868	HELU-S-PK-AL-DIN 25-10	25,0 - 35,0	10,5	6,8	18,0	60,0	12	15,3	50	o. r.	o. r.	o. r.
907869	HELU-S-PK-AL-DIN 35-8	35,0 - 50,0	8,4	8,0	20,0	67,0	14	24,5	50	o. r.	o. r.	o. r.
907870	HELU-S-PK-AL-DIN 35-10	35,0 - 50,0	10,5	8,0	20,0	67,0	14	24,5	50	o. r.	o. r.	o. r.
907871	HELU-S-PK-AL-DIN 35-12	35,0 - 50,0	13,0	8,0	20,0	67,0	14	23,5	50	o. r.	o. r.	o. r.
907872	HELU-S-PK-AL-DIN 50-8	50,0 - 70,0	8,4	10,0	23,0	74,0	16	32,9	25	o. r.	o. r.	o. r.
907873	HELU-S-PK-AL-DIN 50-10	50,0 - 70,0	10,5	10,0	23,0	74,0	16	28,8	25	o. r.	o. r.	o. r.
907874	HELU-S-PK-AL-DIN 50-12	50,0 - 70,0	13,0	10,0	23,0	74,0	16	33,8	25	o. r.	o. r.	o. r.
907875	HELU-S-PK-AL-DIN 70-10	70,0 - 95,0	10,5	11,5	28,0	84,0	18	47,7	25	o. r.	o. r.	o. r.
907876	HELU-S-PK-AL-DIN 70-12	70,0 - 95,0	13,0	11,5	28,0	87,0	18	47,3	25	o. r.	o. r.	o. r.
907877	HELU-S-PK-AL-DIN 95-10	95,0 - 120,0	10,5	13,2	32,0	90,0	22	70,1	10	o. r.	o. r.	o. r.
907878	HELU-S-PK-AL-DIN 95-12	95,0 - 120,0	13,0	13,2	32,0	90,0	22	78,2	10	o. r.	o. r.	o. r.
907879	HELU-S-PK-AL-DIN 95-16	95,0 - 120,0	17,0	13,2	32,0	90,0	22	76,2	10	o. r.	o. r.	o. r.
907880	HELU-S-PK-AL-DIN 120-10	120,0 - 150,0	10,5	14,7	32,0	98,0	22	83,8	10	o. r.	o. r.	o. r.
907881	HELU-S-PK-AL-DIN 120-12	120,0 - 150,0	13,0	14,7	32,0	98,0	22	87,9	10	o. r.	o. r.	o. r.
907882	HELU-S-PK-AL-DIN 120-16	120,0 - 150,0	17,0	14,7	32,0	98,0	22	86,4	10	o. r.	o. r.	o. r.
906459	HELU-S-PK-AL-DIN 150-10	150,0 - 185,0	10,5	16,3	35,0	104,0	25	99,8	10	o. r.	o. r.	o. r.
906436	HELU-S-PK-AL-DIN 150-12	150,0 - 185,0	13,0	16,3	35,0	104,0	25	102,3	10	o. r.	o. r.	o. r.
906461	HELU-S-PK-AL-DIN 150-16	150,0 - 185,0	13,0	16,3	35,0	104,0	25	100,8	10	o. r.	o. r.	o. r.
906462	HELU-S-PK-AL-DIN 150-20	150,0 - 185,0	21,0	16,3	35,0	104,0	25	100,2	10	o. r.	o. r.	o. r.
907883	HELU-S-PK-AL-DIN 185-10	185,0 - 240,0	10,5	18,5	40,0	109,0	28	133,9	10	o. r.	o. r.	o. r.
906463	HELU-S-PK-AL-DIN 185-12	185,0 - 240,0	13,0	18,5	40,0	109,0	28	133,9	10	o. r.	o. r.	o. r.
906464	HELU-S-PK-AL-DIN 185-16	185,0 - 240,0	17,0	18,5	40,0	109,0	28	137,5	10	o. r.	o. r.	o. r.
906465	HELU-S-PK-AL-DIN 185-20	185,0 - 240,0	21,0	18,5	40,0	109,0	28	137,5	10	o. r.	o. r.	o. r.
907884	HELU-S-PK-AL-DIN 240-10	240,0 - 300,0	10,5	21,0	46,0	119,0	32	182,8	10	o. r.	o. r.	o. r.
906466	HELU-S-PK-AL-DIN 240-12	240,0 - 300,0	13,0	21,0	46,0	119,0	32	179,4	10	o. r.	o. r.	o. r.
906467	HELU-S-PK-AL-DIN 240-16	240,0 - 300,0	17,0	21,0	46,0	119,0	32	176,2	10	o. r.	o. r.	o. r.
906468	HELU-S-PK-AL-DIN 240-20	240,0 - 300,0	21,0	21,0	46,0	119,0	32	179,0	10	o. r.	o. r.	o. r.
906469	HELU-S-PK-AL-DIN 300-12	300,0	13,0	23,3	50,0	125,0	38	205,4	5	o. r.	o. r.	o. r.
906470	HELU-S-PK-AL-DIN 300-16	300,0	17,0	23,3	50,0	125,0	38	201,4	5	o. r.	o. r.	o. r.
906471	HELU-S-PK-AL-DIN 300-20	300,0	21,0	23,3	50,0	125,0	38	194,3	5	o. r.	o. r.	o. r.
906472	HELU-S-PK-AL-DIN 400-12	400,0	13,0	26,0	55,0	120,0	38	283,0	5	o. r.	o. r.	o. r.
906473	HELU-S-PK-AL-DIN 400-16	400,0	17,0	26,0	55,0	120,0	38	273,3	5	o. r.	o. r.	o. r.
906474	HELU-S-PK-AL-DIN 400-20	400,0	21,0	26,0	55,0	120,0	38	240,0	5	o. r.	o. r.	o. r.
906475	HELU-S-PK-AL-DIN 500-12	500,0	13,0	29,0	63,0	140,0	44	380,0	5	o. r.	o. r.	o. r.
906476	HELU-S-PK-AL-DIN 500-16	500,0	17,0	29,0	63,0	140,0	44	378,0	5	o. r.	o. r.	o. r.
906477	HELU-S-PK-AL-DIN 500-20	500,0	21,0	29,0	63,0	140,0	44	373,5	5	o. r.	o. r.	o. r.

Dimensions and specifications may be changed without prior notice.

o. r. = on request

HELU-S-PK-AL/CU Aluminium/copper compression cable lug - straight



Compression cable lug HELU-S-PK-AL/CU

Non-insulated, straight compression lug in eye type design made of aluminium. High quality version for reliable crimping. Designed for conductor type RM and circular reshaped conductors.

Material

Socket: Al 99,5 and Cu acc. to DIN EN 13601
Surface: bare

Note

- Code type indicates the required hexagonal crimping insert.
- Al-sleeves are prefilled with contact grease and sealed with plastic plugs

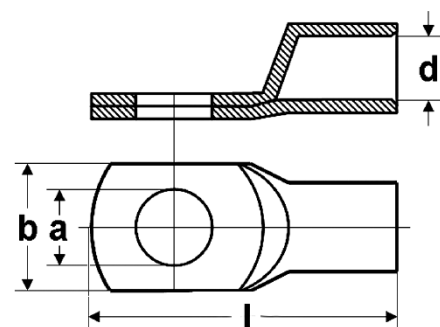

Dimensions

- a Diameter of the boring
- d Inner diameter of the cable inclusion
- b Flange width
- l Length

Part no.	Cross-section RM/SM - SE mm ²	Boring M	a mm	d mm	b mm	l mm	Code type	Weight kg / 1000 items	Unit	Net EUR/100 items at a purchase of		
										up to 500	501 - 1000	1001 - 5000
907568	10 - -	8	8,4	5,0	20,0	50,0	10	26,5	25	o. r.	o. r.	o. r.
907569	16 - 25	8	8,4	5,6	20,0	60,0	12	35,4	25	o. r.	o. r.	o. r.
907570	16 - 25	10	10,5	5,6	20,0	60,0	12	34,2	25	o. r.	o. r.	o. r.
907571	25 - 35	8	8,4	6,8	20,0	65,0	12	35,7	25	o. r.	o. r.	o. r.
907572	25 - 35	10	10,5	6,8	20,0	65,0	12	34,4	25	o. r.	o. r.	o. r.
907573	25 - 35	12	13,0	6,8	26,0	67,0	12	44,5	25	o. r.	o. r.	o. r.
907574	35 - 50	8	8,4	8,0	20,0	75,0	14	45,5	25	o. r.	o. r.	o. r.
907575	35 - 50	10	10,5	8,0	20,0	75,0	14	44,2	25	o. r.	o. r.	o. r.
907576	35 - 50	12	13,0	8,0	26,0	75,0	14	51,5	25	o. r.	o. r.	o. r.
907577	50 - 70	8	8,4	9,8	20,0	75,0	16	48,7	25	o. r.	o. r.	o. r.
907578	50 - 70	10	10,5	9,8	20,0	75,0	16	47,2	25	o. r.	o. r.	o. r.
907579	50 - 70	12	13,0	9,8	26,0	75,0	16	59,9	25	o. r.	o. r.	o. r.
907580	70 - 95	8	8,4	11,2	26,0	85,0	18	61,9	10	o. r.	o. r.	o. r.
907581	70 - 95	0	10,5	11,2	26,0	10,0	18	73,7	10	o. r.	o. r.	o. r.
907582	70 - 95	0	13,0	11,2	26,0	85,0	18	73,7	10	o. r.	o. r.	o. r.
907583	70 - 95	16	17,0	11,2	30,0	88,0	18	81,0	10	o. r.	o. r.	o. r.
907584	95 - 120	8	8,4	13,2	26,0	86,0	22	102,9	10	o. r.	o. r.	o. r.
907585	95 - 120	10	10,5	13,2	26,0	86,0	22	105,9	10	o. r.	o. r.	o. r.
907586	95 - 120	12	13,0	13,2	26,0	86,0	22	103,4	10	o. r.	o. r.	o. r.
907587	95 - 120	16	17,0	13,2	30,0	88,0	22	109,9	10	o. r.	o. r.	o. r.
907588	120 - 150	8	8,4	14,7	26,0	88,0	22	106,8	10	o. r.	o. r.	o. r.
907589	120 - 150	10	10,5	14,7	26,0	88,0	22	106,8	10	o. r.	o. r.	o. r.
907590	120 - 150	12	13,0	14,7	26,0	88,0	22	104,5	10	o. r.	o. r.	o. r.
907591	120 - 150	16	17,0	14,7	30,0	90,0	22	114,5	10	o. r.	o. r.	o. r.
907592	150 - 185	8	8,4	16,3	30,0	100,0	25	138,8	5	o. r.	o. r.	o. r.
906478	150 - 185	10	10,5	16,3	30,0	100,0	25	138,0	5	o. r.	o. r.	o. r.
906172	150 - 185	12	13,0	16,3	30,0	100,0	25	135,7	5	o. r.	o. r.	o. r.
906173	150 - 185	16	17,0	16,3	30,0	100,0	25	128,8	5	o. r.	o. r.	o. r.
907593	185 - 240	8	8,4	18,3	30,0	102,0	28	183,7	5	o. r.	o. r.	o. r.
906479	185 - 240	10	10,5	18,3	30,0	102,0	28	176,1	5	o. r.	o. r.	o. r.
906480	185 - 240	12	13,0	18,3	30,0	102,0	28	173,1	5	o. r.	o. r.	o. r.
906481	185 - 240	16	17,0	18,3	36,0	105,0	28	196,8	5	o. r.	o. r.	o. r.
906482	185 - 240	8	21,0	18,3	36,0	105,0	28	189,7	5	o. r.	o. r.	o. r.
906483	240 - 300	10	10,5	21,0	30,0	112,0	32	204,1	5	o. r.	o. r.	o. r.
906185	240 - 300	12	13,0	21,0	30,0	112,0	32	204,1	5	o. r.	o. r.	o. r.
906484	240 - 300	16	17,0	21,0	36,0	115,0	32	225,8	5	o. r.	o. r.	o. r.
906485	240 - 300	20	21,0	21,0	36,0	115,0	32	218,5	5	o. r.	o. r.	o. r.

HELU-S-PK-AL/CU Copper compression cable lug – straight

Part no.	Cross-section RM/SM - SE mm ²	Boring M	a mm	d mm	b mm	l mm	Code type	Weight kg / 1000 items	Unit	Net EUR/100 items at a purchase of		
										up to 500	501 - 1000	1001 - 5000
906486	300 - -	10	10,5	23,3	30,0	115,0	34	225,0	5	o. r.	o. r.	o. r.
906487	300 - -	12	13,0	23,3	30,0	116,0	34	218,4	5	o. r.	o. r.	o. r.
906488	300 - -	16	17,0	23,3	36,0	116,0	34	226,4	5	o. r.	o. r.	o. r.
906489	300 - -	20	21,0	23,3	36,0	116,0	34	232,2	5	o. r.	o. r.	o. r.
906490	400 - -	10	10,5	26,0	36,0	125,0	38	225,0	5	o. r.	o. r.	o. r.
906212	400 - -	12	13,0	26,0	36,0	125,0	38	328,7	5	o. r.	o. r.	o. r.
906174	400 - -	16	17,0	26,0	36,0	125,0	38	332,7	5	o. r.	o. r.	o. r.
906175	400 - -	20	21,0	26,0	36,0	125,0	38	352,6	5	o. r.	o. r.	o. r.
906491	500 - -	10	10,5	29,0	44,0	140,0	44	341,5	1	o. r.	o. r.	o. r.
906492	500 - -	12	13,0	29,0	44,0	140,0	44	437,1	1	o. r.	o. r.	o. r.
906493	500 - -	16	17,0	29,0	44,0	140,0	44	433,3	1	o. r.	o. r.	o. r.
906494	500 - -	20	21,0	29,0	44,0	140,0	44	428,3	1	o. r.	o. r.	o. r.
907594	625 - -	12	13,0	35,0	50,0	177,0	52	420,8	1	o. r.	o. r.	o. r.
907595	625 - -	16	17,0	35,0	50,0	177,0	52	630,1	1	o. r.	o. r.	o. r.
907596	625 - -	20	21,0	35,0	50,0	177,0	52	770,0	1	o. r.	o. r.	o. r.
								763,0	1	o. r.	o. r.	o. r.

Dimensions and specifications may be changed without prior notice.

o. r. = on request

HELU-S-SV-CU Copper tubular butt connectors



Compression joint

HELU-S-SV-CU

Clamping connection sleeves for unstrained clamping.

Type: With wirestop

Material

Socket: Cu according to DIN EN 13600

Surface: tin plated

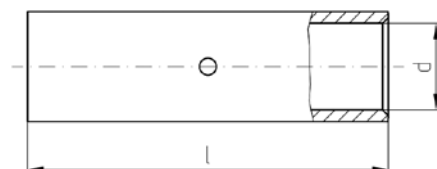

Dimensions

d Inner diameter of the cable inclusion
l Length

Part no.	Type	Cross-section mm ²	d mm	l mm	Code type	Weight kg / 1000 items	Unit	Net EUR/ 100 items at a purchase of		
								up to 100	101 - 500	501 - 1000
907811	HELU-S-SV-CU 0,5-0,75	0,5	1,4	15,0	-	0,8	100	o. r.	o. r.	o. r.
907812	HELU-S-SV-CU 1-1,5	1,0	1,9	15,0	-	1,2	100	o. r.	o. r.	o. r.
907813	HELU-S-SV-CU 2,5	2,5	2,4	16,0	-	1,5	100	o. r.	o. r.	o. r.
907814	HELU-S-SV-CU 4	4,0	3,0	19,0	-	2,1	100	o. r.	o. r.	o. r.
907815	HELU-S-SV-CU 6	6,0	3,5	25,0	-	5,1	100	o. r.	o. r.	o. r.
907816	HELU-S-SV-CU 10	10,0	4,5	30,0	-	6,0	50	o. r.	o. r.	o. r.
907817	HELU-S-SV-CU 16	16,0	5,5	35,0	-	10,0	50	o. r.	o. r.	o. r.
907818	HELU-S-SV-CU 25	25,0	7,0	40,0	-	14,1	50	o. r.	o. r.	o. r.
907819	HELU-S-SV-CU 35	35,0	8,5	45,0	-	21,6	50	o. r.	o. r.	o. r.
907820	HELU-S-SV-CU 50	50,0	10,0	50,0	-	33,2	50	o. r.	o. r.	o. r.
907821	HELU-S-SV-CU 70	70,0	12,0	55,0	-	49,1	50	o. r.	o. r.	o. r.
907822	HELU-S-SV-CU 95	95,0	13,5	60,0	-	60,9	50	o. r.	o. r.	o. r.
907823	HELU-S-SV-CU 120	120,0	15,0	65,0	-	78,8	25	o. r.	o. r.	o. r.
907824	HELU-S-SV-CU 150	150,0	16,8	70,0	-	86,8	25	o. r.	o. r.	o. r.
907825	HELU-S-SV-CU 185	185,0	19,0	75,0	-	116,3	25	o. r.	o. r.	o. r.
907826	HELU-S-SV-CU 240	240,0	21,0	85,0	-	142,2	25	o. r.	o. r.	o. r.
907827	HELU-S-SV-CU 300	300,0	24,0	100,0	-	224,0	10	o. r.	o. r.	o. r.
907828	HELU-S-SV-CU 400	400,0	27,5	100,0	-	261,7	10	o. r.	o. r.	o. r.
907829	HELU-S-SV-CU 500	500,0	31,0	140,0	-	473,0	5	o. r.	o. r.	o. r.
907830	HELU-S-SV-CU 630	630,0	34,0	160,0	-	617,5	5	o. r.	o. r.	o. r.

Dimensions and specifications may be changed without prior notice.

o. r. = on request

HELU-S-PV-CU-DIN Copper compressions joint



Compression joint HELU-S-PV-CU-DIN

Clamping connection sleeves for unstrained clamping of conductors built to DIN 46267.

Material

Socket: copper
Surface: tinned

Note

- Code type indicates the required hexagonal clamping insert

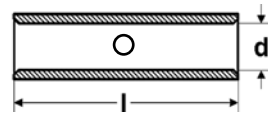

Part no.	Type	Cross-section mm ²	d mm	l mm	Code type	Weight kg / 1000 items	Unit	Net EUR/100 items at a purchase of		
								up to 100	101 - 500	501 - 1000
93263	HELU-S-PV-CU-DIN 6	6,0	3,8	30,0	5,0	3,4	50	o. r.	o. r.	o. r.
93264	HELU-S-PV-CU-DIN 10	10,0	4,5	30,0	6,0	3,4	50	o. r.	o. r.	o. r.
93265	HELU-S-PV-CU-DIN 16	16,0	5,5	50,0	8,0	14,9	50	o. r.	o. r.	o. r.
93266	HELU-S-PV-CU-DIN 25	25,0	7,0	50,0	10,0	18,0	50	o. r.	o. r.	o. r.
93267	HELU-S-PV-CU-DIN 35	35,0	8,2	50,0	12,0	31,5	50	o. r.	o. r.	o. r.
93268	HELU-S-PV-CU-DIN 50	50,0	10,0	56,0	14,0	43,7	50	o. r.	o. r.	o. r.
93269	HELU-S-PV-CU-DIN 70	70,0	11,5	56,0	16,0	55,4	25	o. r.	o. r.	o. r.
93270	HELU-S-PV-CU-DIN 95	95,0	13,5	70,0	18,0	88,4	25	o. r.	o. r.	o. r.
93271	HELU-S-PV-CU-DIN 120	120,0	15,5	70,0	20,0	99,2	25	o. r.	o. r.	o. r.
93272	HELU-S-PV-CU-DIN 150	150,0	17,0	80,0	22,0	148,6	10	o. r.	o. r.	o. r.
93273	HELU-S-PV-CU-DIN 185	185,0	19,0	85,0	25,0	173,5	10	o. r.	o. r.	o. r.
93274	HELU-S-PV-CU-DIN 240	240,0	21,5	90,0	28,0	240,3	10	o. r.	o. r.	o. r.
93275	HELU-S-PV-CU-DIN 300	300,0	24,5	100,0	32,0	298,6	10	o. r.	o. r.	o. r.

Dimensions and specifications may be changed without prior notice.

o. r. = on request

HELU-S-PV-AL-DIN Aluminium press connector



Press connector HELU-S-PV-AL-DIN

Press connector for strain-relieved connections of conductors designed acc. to DIN 46267 part 2.

Material

Socket: Al 99,5
Surface: bare

Note

- Code type indicates the required hexagonal crimping insert.
- Part No. 907835 is not standardized.
- Sleeves are prefilled with contact grease and sealed with plastic plug.

Technical data

Temperature range: up to +120°C

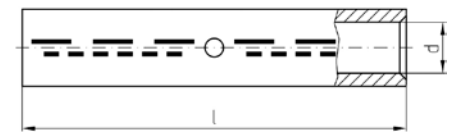

Dimensions

d Inner diameter of the cable inclusion
l Length

Part no.	Cross-section RM/SM - SE mm ²	d mm	l mm	Code type	Weight kg / 1000 items	Unit	Net EUR/ 100 items at a purchase of		
							up to 100	101 - 500	501 - 1000
907835	16 - 25	5,6	55,0	12	13,4	50	o. r.	o. r.	o. r.
906511	25 - 35	6,8	70,0	12	15,4	50	o. r.	o. r.	o. r.
906512	35 - 50	8,0	85,0	14	28,5	50	o. r.	o. r.	o. r.
906513	50 - 70	10,0	85,0	16	34,0	25	o. r.	o. r.	o. r.
906514	70 - 95	11,5	105,0	18	55,9	25	o. r.	o. r.	o. r.
906515	95 - 120	13,2	105,0	22	82,1	10	o. r.	o. r.	o. r.
906516	120 - 150	14,7	105,0	22	86,4	10	o. r.	o. r.	o. r.
906406	150 - 185	16,3	125,0	25	111,3	10	o. r.	o. r.	o. r.
906517	185 - 240	18,5	125,0	28	143,5	10	o. r.	o. r.	o. r.
906518	240 - 300	21,0	145,0	32	191,7	10	o. r.	o. r.	o. r.
906519	300 - -	23,3	145,0	34	227,1	10	o. r.	o. r.	o. r.
906520	400 - -	26,0	210,0	38	359,0	5	o. r.	o. r.	o. r.
906521	500 - -	29,0	210,0	44	455,0	5	o. r.	o. r.	o. r.

Dimensions and specifications may be changed without prior notice.

o. r. = on request

HELU-S-PV-AL/CU Aluminium / Copper press connector



Press Connector HELU-S-PV-AL/CU

Press connector for aluminium conductors, strain relieved

Material

Socket: Al 99,5 and Cu acc. to DIN EN 13601
Surface: bare

Note

Al-sleeves are prefilled with contact grease and sealed with plastic plug.

Technical data

Temperature range: up to +120°C



Dimensions

- d1 Inner diameter of the cable inclusion, copper side
- d2 Inner diameter of the cable inclusion, aluminium side
- l Length

Part no.	Cross-section AL RM/SM - SE mm ²	Cross-section CU SE mm ²	Code type AL / CU	d1 CU mm	d2 AL mm	l mm	Weight kg / 1000 items	Unit	Net EUR/ 100 items at a purchase of		
									up to 100	101 - 500	501 - 1000
907836	16 - 25	6	12 / 5	3,7	5,6	45,0	9,2	25	o. r.	o. r.	o. r.
907837	16 - 25	10	12 / 6	4,4	5,6	45,0	9,4	25	o. r.	o. r.	o. r.
907838	16 - 25	16	12 / 8	5,5	5,6	56,0	15,8	25	o. r.	o. r.	o. r.
907839	25 - 35	10	12 / 6	4,4	6,8	51,0	9,9	25	o. r.	o. r.	o. r.
907840	25 - 35	16	12 / 8	5,5	6,8	61,0	16,1	25	o. r.	o. r.	o. r.
907841	25 - 35	25	12 / 10	7,0	6,8	62,0	19,2	25	o. r.	o. r.	o. r.
907842	35 - 50	16	14 / 8	5,5	8,0	71,0	21,2	25	o. r.	o. r.	o. r.
907843	35 - 50	25	14 / 10	7,0	8,0	71,0	24,1	25	o. r.	o. r.	o. r.
907844	35 - 50	35	14 / 12	8,2	8,0	70,0	29,9	25	o. r.	o. r.	o. r.
907845	50 - 70	25	16 / 10	7,0	9,8	71,5	26,6	25	o. r.	o. r.	o. r.
907846	50 - 70	35	16 / 12	8,2	9,8	71,5	33,4	25	o. r.	o. r.	o. r.
907847	50 - 70	50	16 / 14	10,0	9,8	71,5	43,5	25	o. r.	o. r.	o. r.
907848	70 - 95	25	18 / 10	7,0	11,2	79,0	36,2	10	o. r.	o. r.	o. r.
907849	70 - 95	35	18 / 12	8,2	11,2	79,0	42,2	10	o. r.	o. r.	o. r.
907850	70 - 95	50	18 / 14	10,0	11,2	85,0	53,3	10	o. r.	o. r.	o. r.
907851	70 - 95	70	18 / 16	11,5	11,2	88,0	64,0	10	o. r.	o. r.	o. r.
907852	95 - 120	35	22 / 12	8,2	13,2	79,0	57,4	10	o. r.	o. r.	o. r.
907853	95 - 120	50	22 / 14	10,0	13,2	85,0	69,1	10	o. r.	o. r.	o. r.
907854	95 - 120	70	22 / 26	11,5	13,2	87,0	78,9	10	o. r.	o. r.	o. r.
907855	95 - 120	95	22 / 18	13,5	13,2	94,0	98,8	10	o. r.	o. r.	o. r.
907856	120 - 150	50	22 / 14	10,0	14,7	87,0	66,5	10	o. r.	o. r.	o. r.
907857	120 - 150	70	22 / 16	11,5	14,7	89,0	76,1	10	o. r.	o. r.	o. r.
907858	120 - 150	95	22 / 18	13,5	14,7	97,0	97,7	10	o. r.	o. r.	o. r.
907859	120 - 150	120	22 / 20	15,5	14,7	98,0	108,3	10	o. r.	o. r.	o. r.
906460	150 - 185	70	25 / 16	11,5	16,3	101,0	95,9	5	o. r.	o. r.	o. r.
906495	150 - 185	95	25 / 18	13,5	16,3	108,0	116,6	5	o. r.	o. r.	o. r.
906209	150 - 185	120	25 / 20	15,5	16,3	108,0	125,9	5	o. r.	o. r.	o. r.
906496	150 - 185	150	25 / 22	17,0	16,3	113,0	155,0	5	o. r.	o. r.	o. r.
906497	185 - 240	95	28 / 18	13,5	18,3	108,0	130,0	5	o. r.	o. r.	o. r.
906498	185 - 240	120	28 / 20	15,5	18,3	108,0	140,1	5	o. r.	o. r.	o. r.
906499	185 - 240	150	28 / 22	17,0	18,3	113,0	169,3	5	o. r.	o. r.	o. r.
906500	185 - 240	185	28 / 25	19,0	18,3	116,0	185,3	5	o. r.	o. r.	o. r.
906501	240 - 300	120	32 / 20	15,5	21,0	120,0	173,6	5	o. r.	o. r.	o. r.
906502	240 - 300	150	32 / 22	17,0	21,0	124,0	200,8	5	o. r.	o. r.	o. r.
906503	240 - 300	185	32 / 25	19,0	21,0	127,0	218,4	5	o. r.	o. r.	o. r.
906504	240 - 300	240	32 / 28	21,5	21,0	132,0	280,0	5	o. r.	o. r.	o. r.
906505	300 - -	150	34 / 22	17,0	23,3	124,0	205,1	5	o. r.	o. r.	o. r.
906506	300 - -	185	34 / 25	19,0	23,3	128,0	225,8	5	o. r.	o. r.	o. r.
906507	300 - -	240	34 / 28	21,5	23,3	134,0	290,0	5	o. r.	o. r.	o. r.
906508	300 - -	300	34 / 32	24,5	23,3	144,0	349,0	5	o. r.	o. r.	o. r.
906509	400 - -	185	38 / 25	19,0	26,0	131,0	267,0	1	o. r.	o. r.	o. r.
906210	400 - -	240	38 / 28	21,5	26,0	135,0	329,0	1	o. r.	o. r.	o. r.
906510	400 - -	300	38 / 32	24,5	26,0	145,0	386,0	1	o. r.	o. r.	o. r.
907860	500 - -	240	44 / 28	21,5	29,0	145,0	402,0	1	o. r.	o. r.	o. r.
907861	500 - -	300	44 / 32	24,5	29,0	155,0	464,1	1	o. r.	o. r.	o. r.
907862	500 - -	400	44 / 38	27,5	29,0	173,0	643,6	1	o. r.	o. r.	o. r.

Dimensions and specifications may be changed without prior notice.

KAC-U Bi-metallic washer



Washer KAC-U

Bi-metallic washer for the processing of aluminium-copper materials.
Only for use in dry areas.

Material

E-Al, one side copper plated

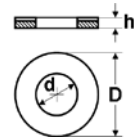

Dimensions

D Outer diameter
d Inner diameter
h Height

Part no.	Size	Inner Ø mm	Outer Ø mm	Thickness mm	Unit	Net EUR/100 items at a purchase of		
						up to 100	101 - 500	501 - 1000
906049	M8 x 1,5	8,5	18,0	1,0	10	o. r.	o. r.	o. r.
906050	M10 x 1,5	11,0	22,0	2,0	10	o. r.	o. r.	o. r.
906051	M12 x 1,5	13,0	28,0	2,0	10	o. r.	o. r.	o. r.
906052	M14 x 1,5	15,0	28,0	2,0	10	o. r.	o. r.	o. r.
906053	M16 x 1,5	17,0	35,0	2,0	10	o. r.	o. r.	o. r.

Dimensions and specifications may be changed without prior notice.

o. r. = on request

TOOLS



■ TABLE OF CONTENTS

TOOLS	22
HELUTOOL HKS 1	24
HELUTOOL HKS 35	25
HELUTOOL HKS 32	26
HELUTOOL HKS 34 S	27
HELUTOOL HKS 52 S	28
HELUTOOL HKM 1	29
HELUTOOL HAM 1	30
HELUTOOL HWZ 6	31
HELUTOOL HWW 6/50	32
HELUTOOL HWW 10/120	33
HELUTOOL HMPI 20	34
HELUTOOL HHPI 20	35
HELUTOOL HAPI 20	36
HELU-S-PE-WM	37
HELU-S-PE-SK	38

HELUTOOL HKS 1 Cable shear



Cable shear HELUTOOL HKS 1

High quality cable shear for cutting finewire stranded Cu- /Al-wires

- blade made of special stainless steel according to EN10020
- ergonomical and extremely robust
- high cutting performance
- loose-free screw/pin fixing
- 2-component-handles
- with special safety box
- Cutting area:
 - straight blade area 0,5-6mm²
 - integrated cable cutter up to 50mm²
- Length: 150mm
- Weight: 170g

Scope of delivery

Cable shear HKS 1, Safetybox

Part no.	Type	Unit	Net EUR/ item at a purchase of		
			1	2 - 4	5 - 10
908229	HKS 1	1	o. r.	o. r.	o. r.

Dimensions and specifications may be changed without prior notice.

o. r. = on request

HELUTOOL HKS 35 Cable shear



Cable shear HELUTOOL HKS 35

High quality forged cable cutter for cutting stranded aluminium and copper cables up to 35mm².

Long life cycle, low efforts during cutting and a clean round cut characterize this cable cutter.

- for cutting cables with outer diameters up to 11mm.
- forged
- tempered blade with precise finish
- burnished
- plastic coated handle
- Length 165mm
- Weight 200g

Part no.	Type	Unit	Net EUR/item at a purchase of		
			1	2 - 4	5 - 10
907602	HKS 35	1	o. r.	o. r.	o. r.

Dimensions and specifications may be changed without prior notice.

o. r. = on request

HELUTOOL HKS 32 Cable shear



Cable shear HKS 32

- with telescopic handles
- for cutting stranded Al- and Cu-cables, single and multi-core
- cutting ranges up to 32mm
- the cutting blades consist of a hardened special tool steel
- Length 600 mm
- Weight 1500 g

Note

Not applicable for cutting steelwires, cables with steel-insertion and solid conductors.

Part no.	Type	Unit	Net EUR/item at a purchase of		
			1	2 - 4	5 - 10
907603	HKS 32	1	o. r.	o. r.	o. r.

Dimensions and specifications may be changed without prior notice.

o. r. = on request

HELUTOOL HKS 34 S Cable cutter



Cable Cutter HKS 34 S

Very robust and smooth running cable cutter for cutting stranded aluminium and copper cables.

- up to 4x70mm² approx. 1x185mm²
- for finewiring conductors up to 34mm outer-diameter
- double needle beared and excentric drive combined with a special blade design guarantees the excellent efficiency of this cable cutter
- Length: 250mm
- Weight: 0,9kg

Note

Not applicable for cutting steel-wires, cables with steel-insertion and solid conductors.

Part no.	Type	Unit	Net EUR/item at a purchase of		
			1	2 - 4	5 - 10
908053	HKS 34 S	1	o. r.	o. r.	o. r.

Dimensions and specifications may be changed without prior notice.

o. r. = on request

HELUTOOL HKS 52 S Cable cutter



Cable cutter HKS 52 S

Very robust and smooth running cable cutter for cutting stranded aluminium and copper cables.

- up to 4x120mm² approx. 1x300mm² and finewiring conductors up to 52mm outside-diameter
- double, needle bared and patented eccentric drive combined with a special blade design guarantees the excellent efficiency of this cable cutter.
- Length: 325mm
- Weight: 1,2kg

Note

Not applicable for cutting steel-wires, cables with steel-insertion and solid conductors.

Part no.	Type	Unit	Net EUR/item at a purchase of		
			1	2 - 4	5 - 10
907605	HKS 52 S	1	o. r.	o. r.	o. r.

Dimensions and specifications may be changed without prior notice.

o. r. = on request

HELUTOOL HKM 1 Cable stripping knife



Cable stripping knife HKM 1

- With special grinding. The special blade prevented a damage of the conductor. The knife has a blade protection, sinking into the handle
- The changeable blade is made of stainless steel according to DIN EN 10020, hardness minimum 50 HRC
- High-quality, ergonomically formed handle is out of impact plastic (PA)
- Admission of the VDE up to 1000 volt according to EN/IEC 60900:2004 and GS-sign
- Length: 200 mm
- Weight: 0,1 kg

Note

Spare blade with moulded plastic insert for HKM 1, part no. 906246

Part no.	Type	Cross-section mm ²	Unit	Net EUR/item at a purchase of		
				1	2 - 4	5 - 10
906245	HKM 1	-	1	o. r.	o. r.	o. r.

Dimensions and specifications may be changed without prior notice.

o. r. = on request

HELUTOOL HAM 1 Skinning tool



Skinning tool HAM 1

- For PVC-insulated round cables and a plurality of PUR-insulated cables up to 25mmØ.
- Suitable for longitudinal and round section. The depth of the cut is adjustable from 0 to 5mm. The cutting blade can be used double-sided.
- Length: 50 mm
- Weight: 0,16 kg

Note

Replacement cutting blade for HAM 1, Part 906234

Scope of delivery

HAM 1 incl. plastic box

Part no.	Type	Cross-section mm ²	Unit	Net EUR/item at a purchase of		
				1	2 - 4	5 - 10
906233	HAM1	-	1	o. r.	o. r.	o. r.

Dimensions and specifications may be changed without prior notice.

o. r. = on request

HELUTOOL HWZ 6 Crimping tool



Crimping tool HWZ 6

Crimping tool for noninsulated terminals from 0,5 up to 16mm². The ratchet guarantees a permanent high quality crimping result.

- Length: 240 mm
- Weight: 0,4 kg

Part no.	Type	Cross-section min. - max. mm ²	Unit	Net EUR/ item at a purchase of		
				1	2 - 4	5 - 10
907611	HWZ 6	0,5 - 16,0	1	o. r.	o. r.	o. r.

Dimensions and specifications may be changed without prior notice.

o. r. = on request

HELUTOOL HWW 6/50 Crimping tool



Crimping tool HWW 6/50

- Crimping tool for crimping tubular cable lugs and connectors of the HELU-S-RK tubular cable lugs and HELU-S-SV tubular butt connectors - series
- Application range: 6 up to 50mm²
- Cross section can be adjusted by turning the in-built revolving dies
- No need of changing dies
- Tool points by small measurements, light weight and an extremely high crimping quality due to WM-crimping
- Length: 380 mm
- Weight: 1,3 kg

Part no.	Type	Cross-section min. - max. mm ²	Unit	Net EUR/item at a purchase of		
				1	2 - 4	5 - 10
907612	HWW 6/50	6,0 - 50,0	1	o. r.	o. r.	o. r.

Dimensions and specifications may be changed without prior notice.

o. r. = on request

HELUTOOL HWW 10/120 Crimping tool



HELUTOOL HWW 10/120

- Crimping tool for crimping tubular cable lugs and connectors of the HELU-S-RK tubular cable lugs and HELU-S-SV tubular butt connectors - series
- Application range: 10- 120mm²
- The cross section can be adjusted by turning the in-built revolving dies
- No need of changing dies
- Feature: Large processing area, light weight and an extremely high crimping quality due to WM-crimping
- Length: 660 mm
- Weight: 4,1 kg

Part no.	Type	Cross-section min. - max. mm ²	Unit	Net EUR/item at a purchase of		
				1	2 - 4	5 - 10
907613	HWW 10/120	10,0 - 120,0	1	o. r.	o. r.	o. r.

Dimensions and specifications may be changed without prior notice.

o. r. = on request

HELUTOOL HMPI 20 Mechanical hand press in toolbox



HELUTOOL HMPI20 Hand-operated mechanical compression tool

Hand-operated mechanical compression tool for crimping cable lugs and connectors up to 300mm²

- Light and compactly construction form
- Universal usage: dies for all versions of cable lugs are available
- 360° revolving head with quick opening and closing
- Continuous moveable telescopic handle
- Press capacity: approx. 60 kN
- Length: 560 up to 830 mm
- Weight: 3,6 kg

Note

Exclusive inserts

Scope of delivery

HELUTOOL HMPI200 including toolbox

Part no.	Type	Cross-section min. - max. mm ²	Unit	Net EUR/item at a purchase of		
				1	2 - 4	5 - 10
907614	HMPI 20	-	1	o. r.	o. r.	o. r.

Dimensions and specifications may be changed without prior notice.

o. r. = on request

HELUTOOL HHPI 20 Hydraulic hand press in toolbox



HELUTOOL HHPI 20 Hydraulic hand press in toolbox

- extremely fast operation through two-stage hydraulic pump
- large processing area up to 300mm²
- rotatable quick release head 180 °
- with folding clasp for effortless operation even in hard reach places
- lightweight and portable, compact design
- built-in pressure relief valve, even in the case of a false pressing no damage to the tool and inserts
- universally applicable: inserts are available for all cable lug types
- Press capacity: ca. 62kN
- Length: 396 mm
- Weight: ca. 2,8 kg

Note
Exclusive inserts

Scope of delivery
HELUTOOL HHPI 20 including toolbox

Part no.	Type	Unit	Net EUR/ item at a purchase of		
			1	2 - 4	5 - 10
908286	HHPI 20	1	o. r.	o. r.	o. r.

Dimensions and specifications may be changed without prior notice.

o. r. = on request

HELUTOOL HAPI 20 Battery hydraulic tool in toolbox



HELUTOOL HAPI 20 Battery hydraulic tool in toolbox

- extremely fast working through two-stage hydraulic pump
- large processing area up to 300 mm²
- Quick release fastener 270 ° rotatable
- Effortless operation by folding clasp even in hard reach places
- Pressure relief button by hand operation available from both sides (left and right)
- Built-in relief valve, even at erroneous pressing no damaging the tool or inserts
- Lithium-ion battery technology, thereby no memory effect, very low self-discharge
- high capacity by 3.0 Ah-battery
- Lug for attaching balancers and carrying belt available
- ergonomic handle with a balanced weight distribution for fatigue-free and safe work
- Casing grip sleeve and pressure relief button entirely of insulating and shock-resistant plastic material
- universal application: inserts for all types of cable shoes available
- built-in electronic module for:
 - Permanent battery power level control
 - Monitoring of the operation and status indication
 - Display of the next service interval
 - Error indication in case of malfunction
- Press capacity: about 62kN
- Operating voltage: 14,4 Volt
- Dimensions (WxHxD):
B 95 x L 350 x H 310 mm
- Weight: 3,9 kg (incl. Battery)
- Charger: 220-240V 50-60Hz 7.2 - 18V
- Charging time approx 50 min.

Note
exclusive dies

Scope of delivery
HELUTOOL HAPI including toolbox

Part no.	Type	Unit	Net EUR/item at a purchase of		
			1	2 - 4	5 - 10
908287	HAPI 20	1	o. r.	o. r.	o. r.

Dimensions and specifications may be changed without prior notice.

o. r. = on request

HELU-S-PE-WM Inserts WM-shape

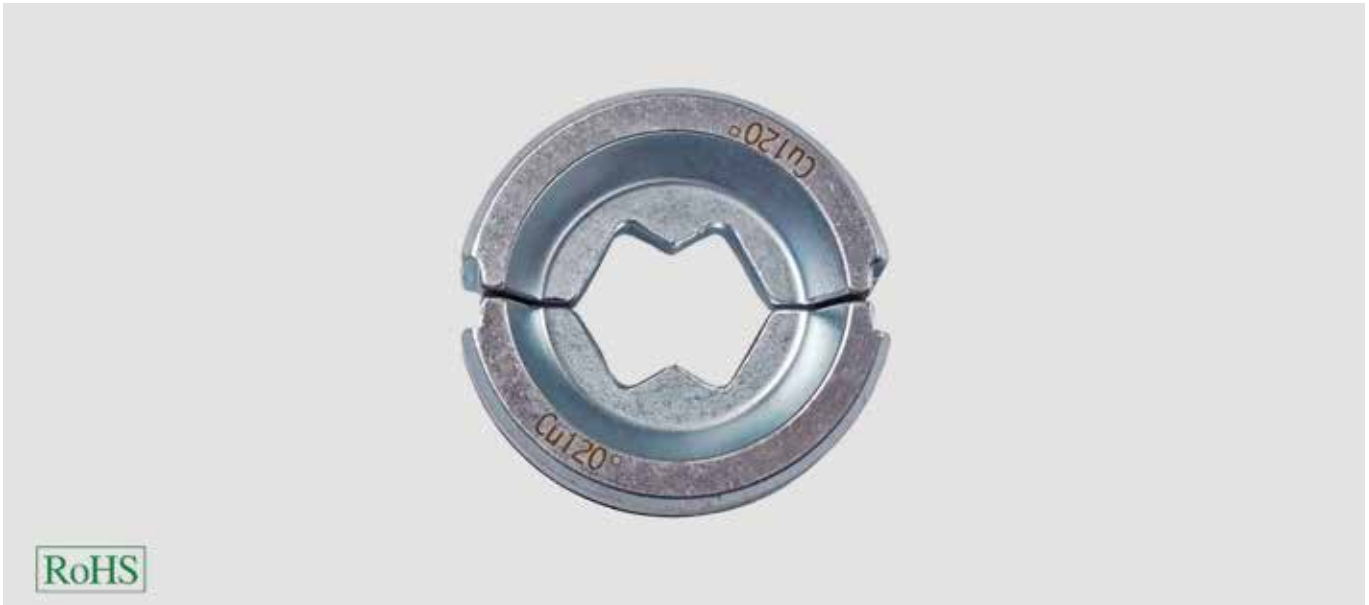

Dies for cable lugs and connectors

For crimping cable lugs and connectors of the HELU-S-RK-CU and HELU-S-SV-CU series

Note

Suitable for:
HELUTOOL HMPI 20, HHPI 20 and HAPI 20

Part no.	Type	Cross-section mm ²	Unit	Net EUR/item at a purchase of		
				1	2 - 4	5 - 10
908230	WMCU6	6,0	1	o. r.	o. r.	o. r.
908231	WMCU10	10,0	1	o. r.	o. r.	o. r.
908232	WMCU16	16,0	1	o. r.	o. r.	o. r.
908233	WMCU25	25,0	1	o. r.	o. r.	o. r.
908234	WMCU35	35,0	1	o. r.	o. r.	o. r.
907615	WMCU50	50,0	1	o. r.	o. r.	o. r.
907616	WMCU70	70,0	1	o. r.	o. r.	o. r.
907617	WMCU95	95,0	1	o. r.	o. r.	o. r.
907618	WMCU120	120,0	1	o. r.	o. r.	o. r.
907619	WMCU150	150,0	1	o. r.	o. r.	o. r.
907620	WMCU185	185,0	1	o. r.	o. r.	o. r.
907621	WMCU240	240,0	1	o. r.	o. r.	o. r.
907622	WMCU300	300,0	1	o. r.	o. r.	o. r.

Dimensions and specifications may be changed without prior notice.

o. r. = on request

HELU-S-PE-SK Inserts hexagonal-shape



Inserts for cable lugs and connectors

For processing HELU-S-PK compression cable lugs and HELU-S-PV tubular compression joints

Note

Suitable for:
HELUTOOL HMPI 20, HHPI 20 and HAPI 20

Part no.	Type	Code type	Cu mm ²	Al mm ²	Unit	Net EUR/item at a purchase of		
						1	2 - 4	5 - 10
908273	SKCU6	5	6	-	1	o. r.	o. r.	o. r.
908274	SKCU10	6	10	-	1	o. r.	o. r.	o. r.
908275	SKCU16	8	16	-	1	o. r.	o. r.	o. r.
908276	SKCU25AL10	10	25	10	1	o. r.	o. r.	o. r.
908277	SKCU35AL16/25	12	35	16 + 25	1	o. r.	o. r.	o. r.
908278	SKCU50AL35	14	50	35	1	o. r.	o. r.	o. r.
908279	SKCU70AL50	16	70	50	1	o. r.	o. r.	o. r.
908280	SKCU95AL70	18	95	70	1	o. r.	o. r.	o. r.
908281	SKCU120	20	120	-	1	o. r.	o. r.	o. r.
908282	SKCU150AL95/120	22	150	95 + 120	1	o. r.	o. r.	o. r.
908283	SKCU185AL150	25	185	150	1	o. r.	o. r.	o. r.
908284	SKCU240AL185	28	240	185	1	o. r.	o. r.	o. r.
908285	SKCU300AL240	32	300	240	1	o. r.	o. r.	o. r.

Dimensions and specifications may be changed without prior notice.

o. r. = on request

Part No. Index

Part no.	Page	Part no.	Page
90910 – 90935	11	907594 – 907596	16
93263 – 93275	18	907597 – 907599	7
906049 – 906053	22	907600	8
906172 – 906173	15	907601	7
906174 – 906175	16	907602	26
906185	15	907603	27
906209	20	907605	29
906210	21	907611	32
906212	16	907612	33
906233	31	907613	34
906245	30	907614	35
906406	19	907615 – 907622	38
906436 – 906459	14	907677 – 907728	12
906460	20	907731 – 907749	13
906461 – 906477	14	907811 – 907830	17
906478 – 906485	15	907835	19
906486 – 906494	16	907836 – 907859	20
906495 – 906508	20	907860 – 907862	21
906509 – 906510	21	907865 – 907884	14
906511 – 906521	19	908053	28
906524 – 906533	12	908229	25
906534 – 906538	13	908230 – 908234	38
907303 – 907317	4	908273 – 908285	39
907318 – 907353	5	908286	36
907354 – 907407	6	908287	37
907467 – 907477	7		
907478	8		
907479 – 907487	7		
907488	8		
907489 – 907492	7		
907493	8		
907494 – 907496	7		
907497	8		
907498 – 907504	7		
907505 – 907507	8		
907508 – 907543	9		
907544 – 907567	10		
907568 – 907593	15		

■ INSTRUCTIONS FOR ASSEMBLY OF CABLE LUGS AND JOINTS – GENERAL

1. The measurements of the cable lugs/joints as well as their cross-section assignment have to be taken from the catalogue.
2. The end of the cable has to be cut right-angled to the joint and to be stripped ca. 10 % corresponding to the length of the cable lug receptacle. (The receptacle elongates a bit during the compression)
3. The wire ends have to be cleaned thoroughly of dirt and oxide rests prior to the compression. Sector wires have to be rounded.
4. The wire is pushed as far as it will go in the cable lug receptacle, or rather to the middle of the joint.
5. Prior to the compression it has to be checked if the wire and the cable lug, or rather the joint, have the same cross-section marking and match according to the catalogue.
6. It has to be detected if the compression tool is ready for the montage with the right compression insert.
7. The compression process, with cable lug and joint, happens from the end of the cable in the direction of the end of the receptacle (see sketch).

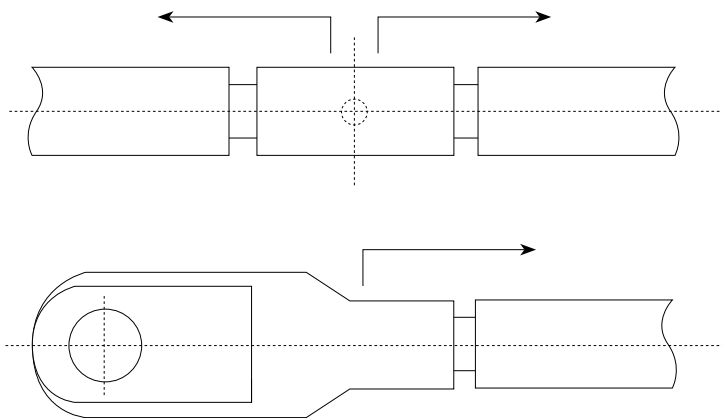

The number of compressions is based on the following tables.

■ COMPRESSION INSTRUCTION

Minimum number of necessary compressions when using HELU-S-RK.tubular lugs and -joints
 HELU-S-SV (WM-compression):

Cross-section in mm	Compression Number x Width	HWW 6/50 907612	HWW 10/120 907613	HMPi 20 907614	HPi 20 908286	HAPi 20 908287
6	1 x 5 mm	•				
	1 x 7 mm			•	•	•
10	1 x 5 mm	•	•			
	1 x 7 mm			•	•	•
16	1 x 5 mm	•	•			
	1 x 7 mm			•	•	•
25	2 x 5 mm	•	•			
	1 x 10 mm			•	•	•
35	2 x 5 mm	•	•	•	•	•
	1 x 10 mm					
	1 x 12 mm					
50	2 x 5 mm	•	•	•	•	•
	1 x 12 mm					
70	2 x 5 mm		•	•	•	•
	1 x 12 mm					
95	2 x 5 mm		•	•	•	•
	1 x 12 mm					
120	3 x 5 mm		•	•	•	•
	2 x 7 mm					
	1 x 12 mm					
150	3 x 5 mm			•	•	•
	2 x 7 mm					
185	3 x 5 mm			•	•	•
	2 x 7 mm					
	2 x 10 mm					
240	3 x 5 mm			•	•	•
	3 x 7 mm					
	2 x 13 mm					
300	4 x 5 mm			•	•	•
	3 x 7 mm					
	2 x 13 mm					

Important : The „instructions for assembly of cable lugs and joints“ have to be followed when producing compressions.
 Joints : Minimum number of necessary compressions per side.

■ COMPRESSION INSTRUCTION

Minimum number of necessary compressions when using CU-compression cable lugs of HELU-S-PK-CU-DIN and HELU-S-PV-CU-DIN series

Cross-section in mm	Index	Compression Number x Width	HMPi 20 90250	HHPi 20 91132	HAPi 20 91142	HAPi 30 91162
6	5	1 x 5 mm				
		1 x 7 mm	•	•	•	•
10	6	1 x 5 mm				
		1 x 7 mm	•	•	•	•
16	8	2 x 5 mm				
		1 x 12 mm	•	•	•	•
25	10	2 x 5 mm				
		1 x 12 mm	•	•	•	•
35	12	2 x 5 mm	•	•	•	
		1 x 10 mm				
		1 x 12 mm				•
50	14	3 x 5 mm	•	•	•	
		1 x 12 mm				•
70	16	3 x 5 mm	•	•	•	
		1 x 12 mm				•
95	18	3 x 5 mm	•	•	•	
		4 x 5 mm	• * DB earthing			
		2 x 10 mm				•
120	20	3 x 5 mm	• * DB earthing			
		4 x 5 mm	•	•	•	
		2 x 10 mm				•
150	22	4 x 5 mm	•	•	•	•
		2 x 10 mm				
185	25	4 x 5 mm	•	•	•	•
		2 x 10 mm				
240	28	4 x 5 mm	•	•	•	•
		2 x 13 mm				
300	32	4 x 5 mm	•	•	•	
		4 x 7 mm				•
		2 x 13 mm				

Important : The „instructions for assembly of cable lugs and joints“ have to be followed when producing compressions.
 Joints : Minimum number of necessary compressions per side.

■ COMPRESSION INSTRUCTION

Minimum number of necessary compressions when using HELUKABEL-compression cable lugs and -joints HELU-S-PK-AL-DIN and HELU-S-PV-AL-DIN-series of aluminium.

Cross-section in mm	Index	Compression Number x Width	HMPi 20 907614	HHPi 20 908286	HAPi 20 908287
10	10	2 x 5 mm 1 x 12 mm	•	•	•
16	10	3 x 5 mm 1 x 12 mm	•	•	•
	12	3 x 5 mm 1 x 10 mm 1 x 12 mm	•	•	•
25	12	4 x 5 mm 1 x 10 mm 2 x 12 mm	•	•	•
35	14	5 x 5 mm 2 x 12 mm	•	•	•
50	16	5 x 5 mm 2 x 12 mm	•	•	•
70	18	6 x 5 mm 3 x 10 mm	•	•	•
95	22	6 x 5 mm 3 x 10 mm	•	•	•
120	22	6 x 5 mm 3 x 10 mm	•	•	•
150	25	6 x 5 mm 3 x 10 mm	•	•	•
185	28	6 x 5 mm 3 x 13 mm	•	•	•
240	32	6 x 5 mm 5 x 7 mm 3 x 13 mm	•	•	•

Important : The „instructions for assembly of cable lugs and joints“ have to be followed when producing compressions.
Joints : Minimum number of necessary compressions per side.

■ CABLE ACCESSORIES

YOU CAN FIND MORE ACCESSORIES IN THE CABLE ACCESSORIES CATALOGUE AND ON WWW.HELUKABEL.DE/ACCESSORIES



Cable glands

- Cable glands for standard applications: made of plastic, made of brass
- Cable glands for special application conditions: for electromagnetic compatibility (EMC), for robust applications and special chemical resistance, for increased usage temperatures, for explosive areas for special installation conditions, for special pressure conditions
- Accessories



Cable protection tubes

- Corrugated tubes: for standard applications, oversized, split corrugated tubes
- Tube connectors
- Highly flexible protection tubes: made of plastic with coil springs, made of metal, spiral wound
- Cable protection tubes for heavy-duty applications
- Metal consults type, plastic-coated
- plastic protection tubes
- Tube connectors for metal protection tubes



Insulating and shrunken tubes

- Braided hoses
- High temperature protection
- Insulating tubes
- Heat-shrink tubing
- End caps
- Accessories



Bundling, binding, fixing

- Plastic helix
- Cable ties
- Velcro fasteners
- Mounting base



Termination and connection sleeves

- Telecommunications cables
- Low voltage
- Medium voltage
- Accessories



Identification and marking

- Marking rings
- Cable markers



Core end sleeves and cable lugs

- Core end sleeves
- Shield connectors
- Quetschkabelschuhe
- Tubular cable lugs
- Compression joint sleeves



Tools

- Socket wrench
- Cable tie tools
- Crimping
- Cutting
- Stripping
- Mounting

NOTES

Technical modifications

© HELUKABEL® GmbH Hemmingen

Specifications have been carefully checked and are believed to be correct; however, no responsibility is assumed for inaccuracies. Subject to technical modifications. Consequently all illustrations, numerical data, etc. are provided without guarantee. Color deviations between photos and delivered goods cannot be avoided. Reproduction or duplication of the text and illustrations, in whole or in part, remain reserved. The transfer of copyrights always requires the written consent of HELUKABEL® GmbH. Our General Terms of Delivery and Payment, which can be viewed at www.helukabel-group.com, apply.

Safety notice

The products described in the catalog are produced in accordance with national and international standards, as well as plant standards; application safety, as stipulated in the safety directives, standards, and statutory regulations, as amended, is provided. With the prerequisite of proper and professional installation and use, the possibility of product-specific dangers can be excluded. For each product this catalog describes general information for use. Independent of the above, the applicable DIN VDE specifications apply. However, installation and processing must only be executed by qualified electricians.

Our General Terms of Delivery and Payment, which can be viewed at www.helukabel-group.com, apply



HELUKABEL®



Logistics-Centre Hemmingen / Stuttgart