

AHM Series



- IT & Medical Approvals
- Energy Efficiency Level V, CEC2008 & EISA 2007
- <0.5 W No Load Input Power
- Class I and Class II Models (Except AHM250)
- Very High Efficiency
- IP22 Environmental Rating
- 3 Year Warranty

Specification

Input

Input Voltage	• 80-264 VAC (see derating curve)
Input Frequency	• 47-63 Hz
Input Current	• 85 W: 0.8 A at 115 VAC, 0.4 A 100 W: 1.0 A at 115 VAC, 0.5 A 150 W: 1.5 A at 115 VAC, 0.75 A 180 W: 1.7 A at 115 VAC, 0.9 A 250 W: 2.3 A at 115 VAC, 0.9 A at 230 VAC
Inrush Current	• 70 A typical, 120 A max at 230 VAC, cold start at 25 °C
Power Factor	• >0.9 at 115 VAC, 60 Hz at 250 VAC
Earth Leakage Current	• 85 W: 70 µA typical, 180 µA max 100 W: 70 µA typical, 180 µA max 150 W: 80 µA typical, 200 µA max 180 W: 80 µA typical, 200 µA max 250 W: 80 µA typical, 200 µA max at 264 VAC/60 Hz
Input Protection	• 85 W: Internal T2.5 A/250 V 100 W: Internal T2.5 A/250 V 150 W: Internal T4.0 A/250 V 180 W: Internal T4.0 A/250 V 250 W: Internal T6.3 A/250 V fuse in line and neutral
No Load Input Power	• <0.5 W

Output

Output Voltage	• See tables
Output Voltage Trim	• Not user-adjustable
Minimum Load	• No minimum load required
Start Up Delay	• 100-300 ms typical, model dependant ⁽¹⁾
Hold Up Time	• 20 ms typical
Line Regulation	• ±1.5% maximum
Load Regulation	• ±3.0% maximum
Transient Response	• 5% max. deviation, recovery to within 1% in 500 µs for a 25% load change
Ripple & Noise	• Typically less than 1%, 1.5% max pk-pk ⁽²⁾
Overvoltage Protection	• 125% typical, Recycle input to reset
Overtemperature Protection	• Unit shuts down, auto recovery
Overload Protection	• 115-175%, auto recovery
Short Circuit Protection	• Trip and restart (hiccup mode)
Temperature Coefficient	• 0.05 %/°C

General

Efficiency	• 92% typical
Energy Efficiency	• Level V
Isolation	• 4000 VAC In to Out, 2 x MOPP 1500 VAC In to Earth, 1 x MOPP 500 VAC Out to Earth, 1 x MOPP
Switching Frequency	• 45-200 KHz variable
Power Density	• 4.4-5.7 W/in ³
MTBF	• 153 kHrs typical to MIL-HDBK-217F at 25 °C, GB

Environmental

Operating Temperature	• 0 °C to +60 °C, derate linearly from 100% power at +40 °C to 60% power at +60 °C
Cooling	• Convection-cooled
Operating Humidity	• 5-95% RH, non-condensing
Storage Temperature	• -40 °C to +85 °C
Operating Altitude	• 3000 m
Shock	• 3 x 30 g/11 ms shocks in both +ve & -ve directions along the 3 orthogonal axis, total 18 shocks.
Vibration	• Three axis 5-500 Hz at 2 g x 10 sweeps

EMC & Safety

Emissions	• EN55011/32, class B conducted EN55011/32, class B radiated
Harmonic Currents	• EN61000-3-2, class A
Voltage Flicker	• EN61000-3-3
ESD Immunity	• EN61000-4-2, level 3, Perf Criteria A
Radiated Immunity	• EN61000-4-3, level 3, Perf Criteria A
EFT/Burst	• EN61000-4-4, level 3, Perf Criteria A
Surge	• EN61000-4-5, installation class 3, Perf Criteria A
Conducted Immunity	• EN61000-4-6, level 3, Perf Criteria A
Magnetic Field	• EN61000-4-8, level 3, Perf Criteria A
Dips & Interruptions	• EN61000-4-11, EN60601-1-2
Safety Approvals	• EN60601-1, ANSI/AAMI ES60601-1, CSA22.2 No. 60601-1 per cUL, Including Risk Management, EN62368-1, UL62368-1. Denan (PSE) certification

Notes

1. See longform datasheet for further information.
2. Measured at the end of the output cable with 10 µF electrolytic and 0.1 µF ceramic capacitor.

Models and Ratings

Output Power	Output Voltage	Output Current	Model Number ⁽¹⁾
85 W	12.0VDC	7.08 A	AHM85PS12
85 W	15.0VDC	5.67 A	AHM85PS15
85 W	19.0VDC	4.47 A	AHM85PS19
85 W	24.0VDC	3.54 A	AHM85PS24
85 W	12.0VDC	7.08 A	AHM85PS12C2
85 W	15.0VDC	5.67 A	AHM85PS15C2
85 W	19.0VDC	4.47 A	AHM85PS19C2
85 W	24.0VDC	3.54 A	AHM85PS24C2

Notes

1. Models with suffix 'C2' have a Class II equipment protection classification.
2. For IEC320-C8 input connector with Class II models, add suffix '-8' to the model number, e.g. AHM85PS24C2-8.
3. For optional input connector retention clip, add suffix '-A' to the model number e.g. AHM85PS24-A, not available for C8 connectors.
4. Alternate case colours available for OEM quantities, contact sales for information.

Mechanical Details

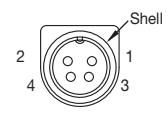
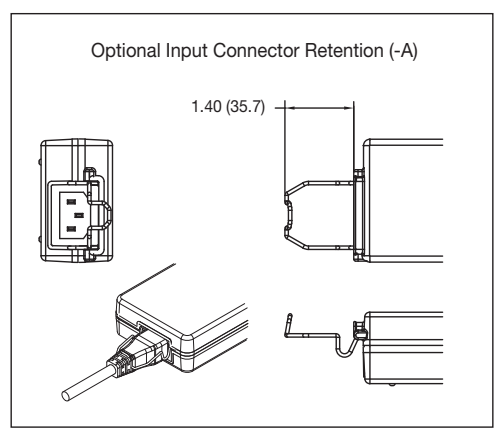
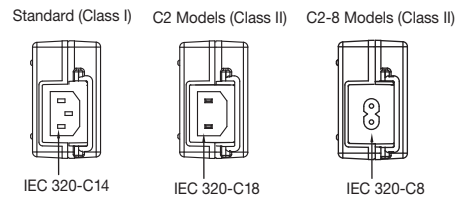
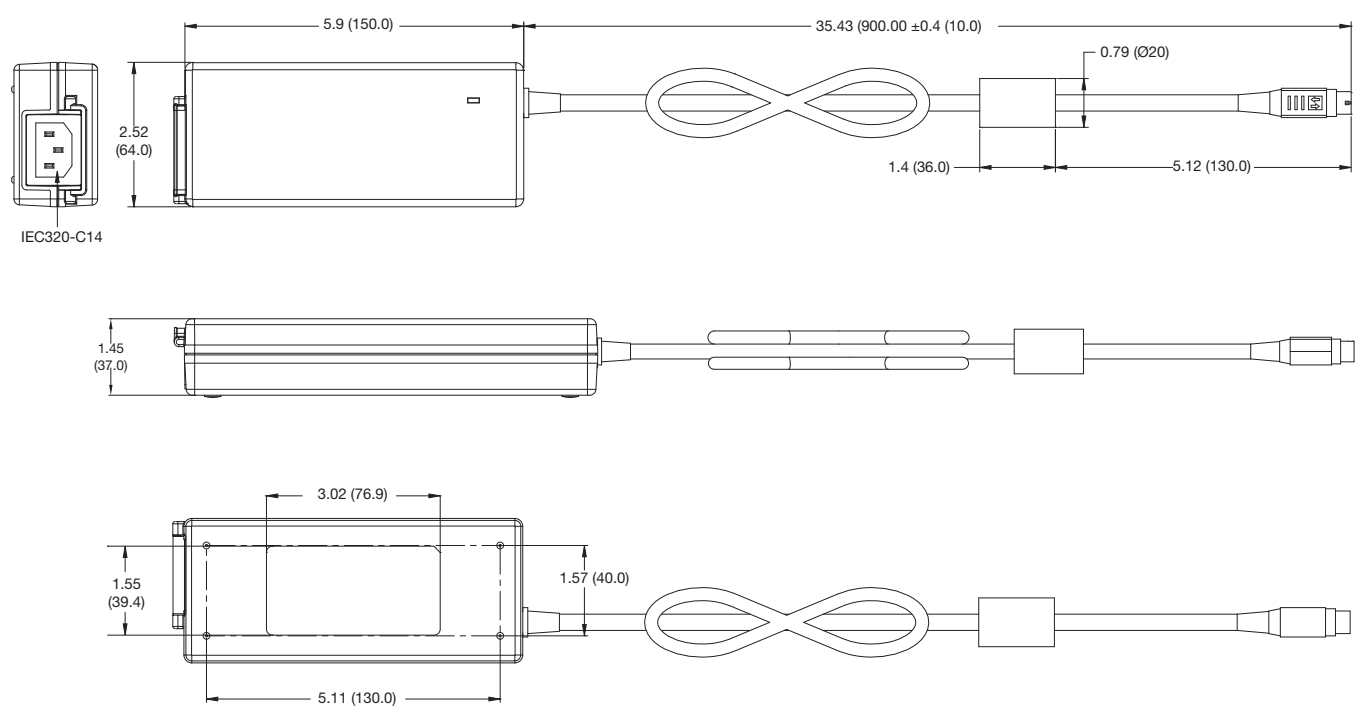

Output Connector equivalent to KPPX-4P (Non Locking)	
Pin 1	Output +
Pin 2	Output +
Pin 3	Return
Pin 4	Return
Outer Shell	GND*
Outer Shell C2 Models	Floating

* Functional earth.

Notes

1. Tolerance is 0.02 (0.5) maximum, except output cable length.
2. Weight 0.9 lbs (400 g).
3. Dimensions shown in inches (mm).
4. Alternate case colours available for OEM quantities, contact sales for information

Models and Ratings

Output Power	Output Voltage	Output Current	Model Number ⁽¹⁾
100 W	12.0 VDC	8.33 A	AHM100PS12
100 W	15.0 VDC	6.67 A	AHM100PS15
100 W	19.0 VDC	5.26 A	AHM100PS19
100 W	24.0 VDC	4.16 A	AHM100PS24
100 W	48.0 VDC	2.08 A	AHM100PS48
100 W	12.0 VDC	8.33 A	AHM100PS12C2
100 W	15.0 VDC	6.67 A	AHM100PS15C2
100 W	19.0 VDC	5.26 A	AHM100PS19C2
100 W	24.0 VDC	4.16 A	AHM100PS24C2
100 W	48.0 VDC	2.08 A	AHM100PS48C2

Notes

1. Models with suffix 'C2' have a class II equipment protection classification.
2. For IEC320-C8 input connector with class II models, add suffix '-8' to the model number, e.g. AHM100PS24C2-8.
3. For optional input connector retention clip, add suffix '-A' to the model number e.g. AHM100PS24-A, not available for C8 connectors.
4. Alternate case colours available for OEM quantities, contact sales for information.

Mechanical Details

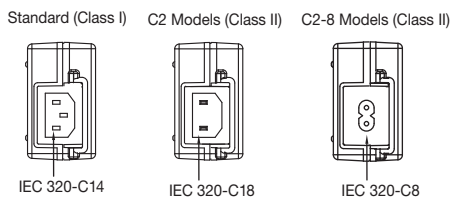
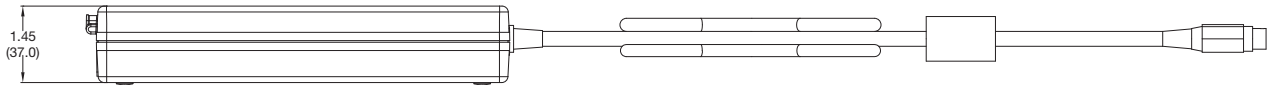
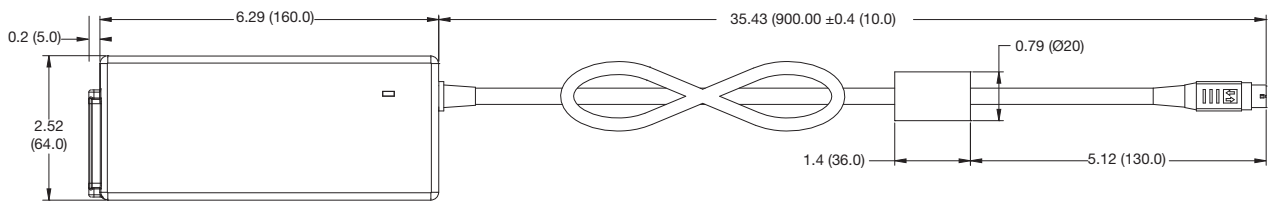

Output Connector equivalent to KPPX-4P (Non Locking)	
Pin 1	Output +
Pin 2	Output +
Pin 3	Return
Pin 4	Return
Outer Shell	GND*
Outer Shell C2 Models	Floating

* Functional earth.

Notes

1. Tolerance is 0.02 (0.5) maximum, except output cable length.
2. Weight 1.1 lbs (500 g).
3. Dimensions shown in inches (mm).

Models and Ratings

Output Power	Output Voltage	Output Current	Model Number ⁽¹⁾
150 W	12.0 VDC	12.50 A	AHM150PS12
150 W	15.0 VDC	10.00 A	AHM150PS15
150 W	19.0 VDC	7.89 A	AHM150PS19
150 W	24.0 VDC	6.25 A	AHM150PS24
150 W	48.0 VDC	3.13 A	AHM150PS48
150 W	12.0 VDC	12.50 A	AHM150PS12C2
150 W	15.0 VDC	10.00 A	AHM150PS15C2
150 W	19.0 VDC	7.89 A	AHM150PS19C2
150 W	24.0 VDC	6.25 A	AHM150PS24C2
150 W	48.0 VDC	3.13 A	AHM150PS48C2

Notes

- For optional input connector retention clip, add suffix '-A' to the model number e.g. AHM150PS24-A, not available for C8 connectors. Models with suffix 'C2' have a class II equipment protection classification. For IEC320-C8 input connector with class II models, add suffix '-8' to the model number, e.g. AHM150PS24C2-8.
- Alternate case colours available for OEM quantities, contact sales for information.

Mechanical Details

Dimensions shown in inches (mm).

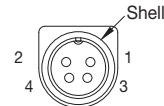
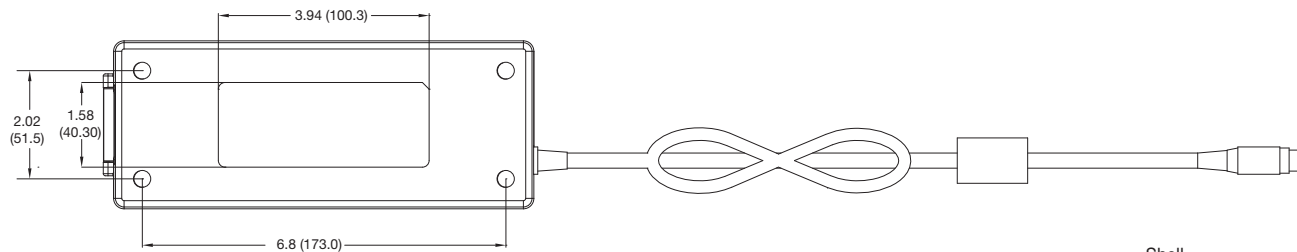
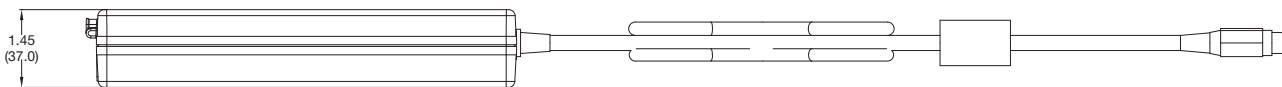
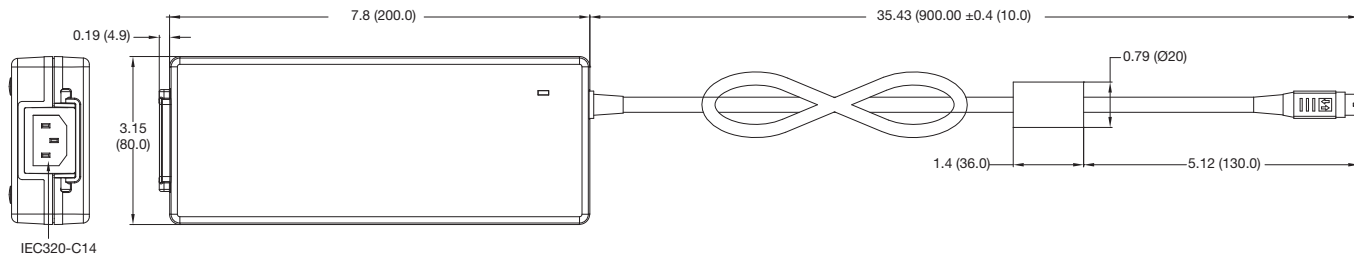

Standard (Class I) C2 Models (Class II) C2-8 Models (Class II)

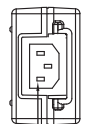

IEC 320-C14

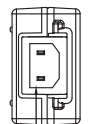

IEC 320-C18

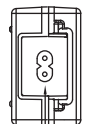

IEC 320-C8

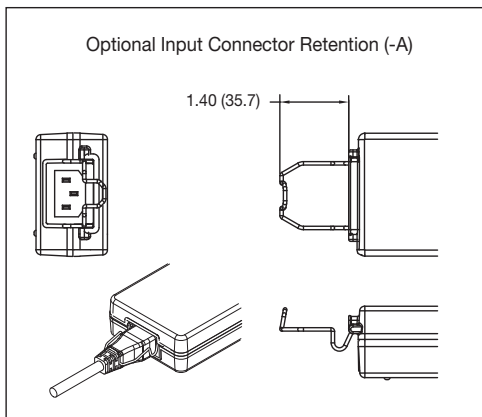

Output Connector equivalent to KPPX-4P (Non Locking)	
Pin 1	Output +
Pin 2	Output +
Pin 3	Return
Pin 4	Return
Outer Shell	GND*
Outer Shell C2 Models	Floating

* Functional earth.

Notes

- Tolerance is 0.02 (0.5) maximum, except output cable length.
- Weight 1.3 lbs (600 g).



Models and Ratings

Output Power	Output Voltage	Output Current	Model Number
165 W	12.0 VDC	13.75 A	AHM180PS12
180 W	15.0 VDC	12.00 A	AHM180PS15
180 W	19.0 VDC	9.47 A	AHM180PS19
180 W	24.0 VDC	7.50 A	AHM180PS24
180 W	48.0 VDC	3.75 A	AHM180PS48
165 W	12.0 VDC	13.75 A	AHM180PS12C2
180 W	15.0 VDC	12.00 A	AHM180PS15C2
180 W	19.0 VDC	9.47 A	AHM180PS19C2
180 W	24.0 VDC	7.50 A	AHM180PS24C2
180 W	48.0 VDC	3.75 A	AHM180PS48C2

Notes

- For optional input connector retention clip, add suffix '-A' to the model number e.g. AHM180PS24-A, not available for C8 connectors. Models with suffix 'C2' have a class II equipment protection classification. For IEC320-C8 input connector with class II models, add suffix '-8' to the model number, e.g. AHM180PS24C2-8.
- Alternate case colours available for OEM quantities, contact sales for information.

Mechanical Details

Dimensions shown in inches (mm).

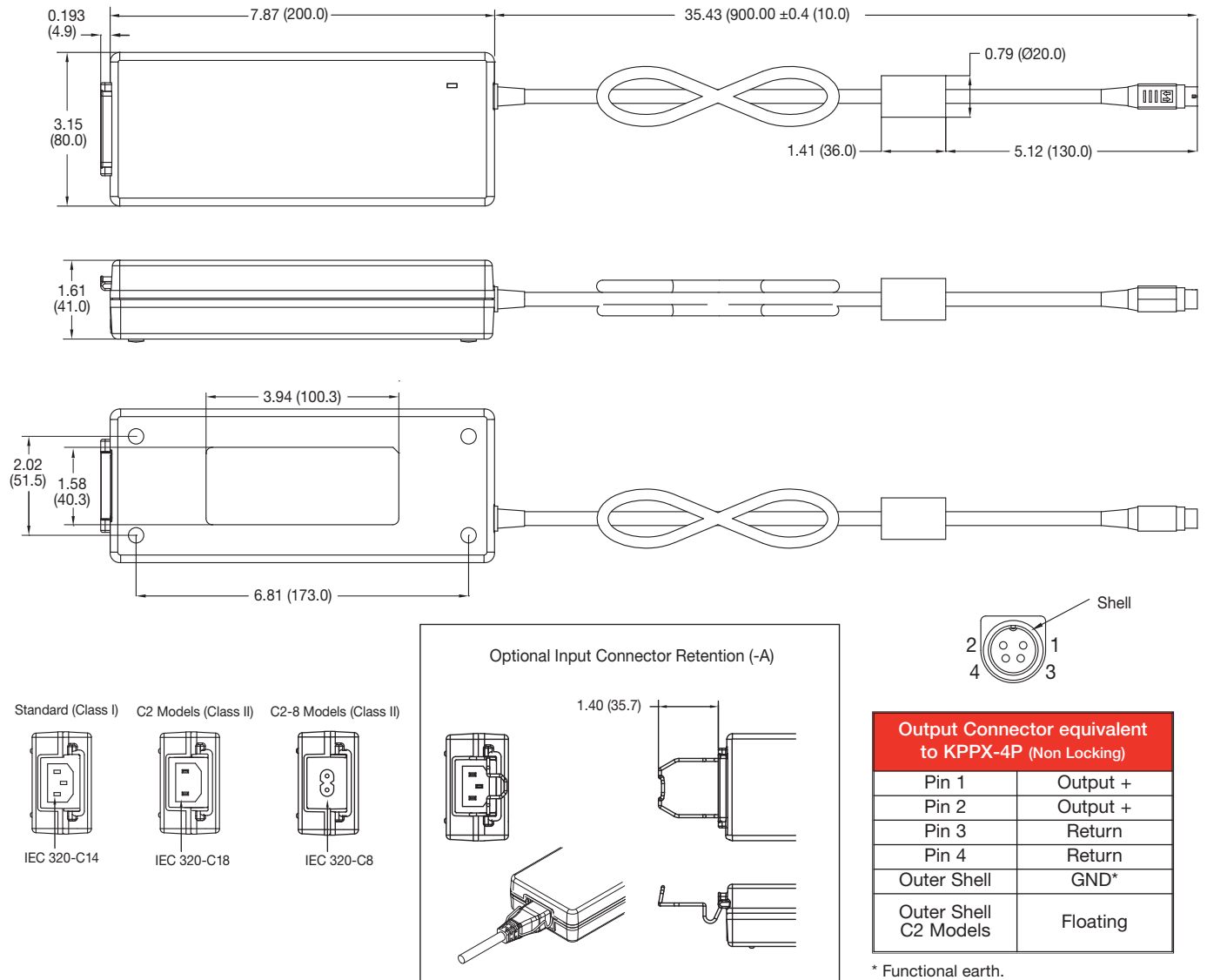

Notes

- Dimensions shown in inches (mm). Tolerance is 0.02 (0.5) maximum, except output cable length.
- Weight 1.4 lbs (620 g)

Models and Ratings

Output Power	Output Voltage	Output Current	Model Number ⁽²⁾
210 W	12.0 VDC	17.50 A	AHM250PS12T
220 W	15.0 VDC	14.66 A	AHM250PS15T
240 W	19.0 VDC	12.63 A	AHM250PS19T
250 W	24.0 VDC	10.41 A	AHM250PS24T
250 W	48.0 VDC	5.21 A	AHM250PS48T

Notes

1. For optional input connector retention clip, add suffix '-A' to the model number e.g. AHM250PS24T-A.
2. For 6 pin DIN connector, remove 'T' from the end of the model number e.g. AHM250PS24 (DIN connector for medical applications only).

Mechanical Details

Dimensions shown in inches (mm).

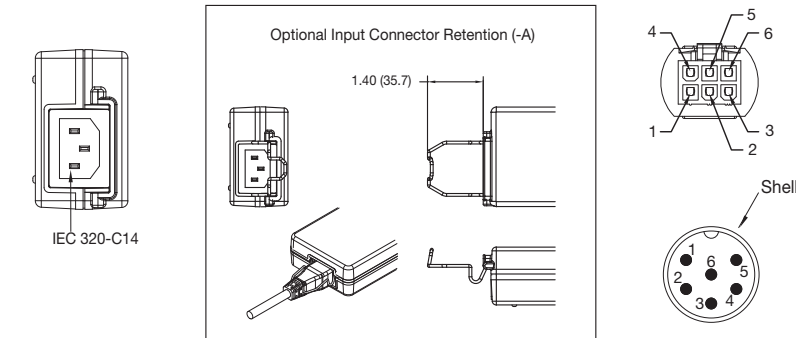

OUTPUT CONNECTOR		
Pin No.	Molex Part No.: 39-03-9062	Male DIN45322 series
Pin 1	Return	Output +
Pin 2	Return	Return
Pin 3	Return	Return
Pin 4	Output +	Return
Pin 5	Output +	Output +
Pin 6	Output +	Output +
Outer Shell		GND*

* Functional earth.

Notes

1. Dimensions shown in inches (mm). Tolerance is 0.02 (0.5) maximum, except output cable length.
2. Weight 2.2 lbs (1000 g).

Derating Curve

