

**Features**

- MEANWELL Patent Application Number: 202330347779.4
- Interchangeable AC plugs
- Global certificates in multi-fields  
(ITE 62368-1, Medical 60601-1, Household 60335-1, Industrial 61558-1/-2-16)
- Universal AC input / Full range
- Ultra slim(30mm)
- No load power consumption < 0.075W
- Energy efficiency Level VI
- Class II power (no earth pin)
- Protections: Short circuit / Overload / Over voltage
- Pass LPS
  - Extremely leakage current <100uA
- -30°C~+70°C wide range working temperature
- Various DC plug quick adapter accessory available  
(Plug kit sold sperately, please refer to : [https://www.meanwell.com/upload/pdf/DC\\_plug.pdf](https://www.meanwell.com/upload/pdf/DC_plug.pdf))
- 3 years warranty

**Applications**

- Consumer electronic devices
- Telecommunication devices
- Office facilities
- Industrial equipments
- Medical devices
- Household devices

**GTIN CODE**

MW Search: <https://www.meanwell.com/serviceGTIN.aspx>

**Description**

NGE65 is a highly reliable, 65W wall-mounted style single-output green adaptor series, which is compact and convenient for carry. This product is equipped with 5 types of interchangeable AC plug (European, USA,U.K. ,Australian and China type) that makes it very suitable for travel use .NGE65 is a class II power unit (no FG), accepting the Input range from 80VAC to 264VAC that it can satisfy the demands for various types of electrical devices.

With the working efficiency up to 92% and the extremely low no-load power consumption below 0.075W, NGE65 is compliant with the latest USA energy regulation EISA 2007/DoE, Canada NRCan,Australia and New Zealand MEPS,EU ErP and CoC version 5. The supreme feature allows the adaptor to save the energy when it is under either the operating mode or the standby mode. The entire series is approved for ITE, medical, household and industrial appliance safety regulations; moreover, it adopts the 94V-0 flame retardant plastic case that it can effectively prevent users from electric hazard.

**Model Encoding**



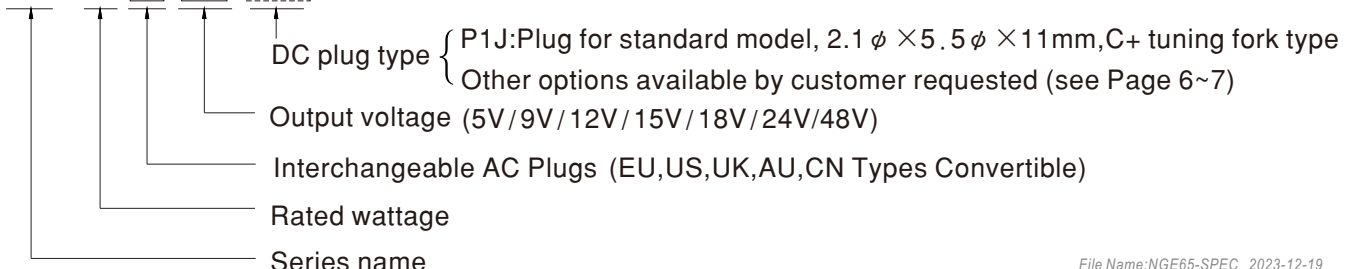







**NGE 65 I 12 -P1J**







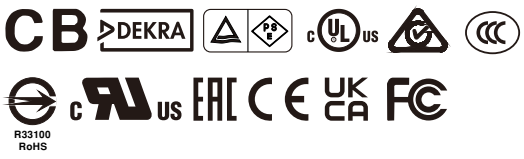

**SPECIFICATION**

MODEL NO.		NGE65○05-P1J	NGE65○09-P1J	NGE65○12-P1J	NGE65○15-P1J	NGE65○18-P1J	NGE65○24-P1J	NGE65○48-P1J	
		○ = I, U, E							
OUTPUT	DC VOLTAGE <small>Note.2</small>	5V	9V	12V	15V	18V	24V	48V	
	RATED CURRENT	6A	5.96A	4.88A	4.34A	3.62A	2.71A	1.36A	
	CURRENT RANGE	0 ~ 6A	0 ~ 5.96A	0 ~ 4.88A	0 ~ 4.34A	0 ~ 3.62A	0 ~ 2.71A	0 ~ 1.36A	
	RATED POWER	30W	53.6W	58.5W	65.1W	65.1W	65W	65.2W	
	RIPPLE & NOISE (max.) <small>Note.3</small>	100mVp-p	100mVp-p	120mVp-p	150mVp-p	180mVp-p	240mVp-p	240mVp-p	
	VOLTAGE TOLERANCE <small>Note.4</small>	±6.0%	±5.0%	±3.0%	±3.0%	±3.0%	±2.0%	±2.0%	
	LINE REGULATION <small>Note.5</small>	±1.0%	±1.0%	±1.0%	±1.0%	±1.0%	±1.0%	±1.0%	
	LOAD REGULATION <small>Note.6</small>	±6.0%	±5.0%	±3.0%	±3.0%	±3.0%	±2.0%	±2.0%	
SETUP, RISE, HOLD UP TIME	1500ms, 50ms, 30ms / 230VAC      3000ms, 50ms, 10ms / 115VAC at full load								
INPUT	VOLTAGE RANGE <small>Note.7</small>	80 ~ 264VAC		113 ~ 370VDC					
	FREQUENCY RANGE	47 ~ 63Hz							
	EFFICIENCY (Typ.)	84%	89%	90%	90%	91%	92%	92%	
	AC CURRENT	1.5A / 115VAC		0.8A / 230VAC					
	INRUSH CURRENT (max.)	COLD START 50A / 115VAC    100A / 230VAC							
LEAKAGE CURRENT (max.)	Touch current < 100uA (rms) @264VAC								
PROTECTION	OVERLOAD	110% ~ 150% rated output power Protection type : 5~24V Hiccup mode, recovers automatically after fault condition is removed. 48V Shut down and latch off o/p voltage, re-power on to recover.							
	OVER VOLTAGE	110% ~ 140% rated output voltage Protection type : Clamp by zener diode							
ENVIRONMENT	WORKING TEMP.	-30 ~ +70°C (Refer to "Derating Curve")							
	WORKING HUMIDITY	20% ~ 90% RH non-condensing							
	STORAGE TEMP., HUMIDITY	-20 ~ +85°C, 10 ~ 95% RH non-condensing							
	TEMP. COEFFICIENT	±0.03% / °C (0 ~ 40°C)							
VIBRATION	10 ~ 500Hz, 2G 10min./1cycle, period for 60min. each along X, Y, Z axes								
SAFETY & EMC <small>(Note. 8)</small>	SAFETY STANDARDS	CB IEC62368-1, IEC60601-1/-1-11, IEC61558-1/-2-16, IEC60335-1; UL UL62368-1, CSA C22.2 NO. 62368-1, ANSI/AAMI ES60601-1/-1-11(3.2 Version), CAN/CSA-C22.2 NO.60601-1/-1-11; DEKRA BS EN/EN62368-1, BS EN/EN60601-1/-1-11, BS EN/EN61558-1/-2-16, BS EN/EN60335-1; PSE J62368-1; BSMI CNS15598-1; RCM AS/NZS 61558-1/-2-16; EAC TPTC004; CCC GB4943.1 approved. (Please refer to next page for more details)							
	WITHSTAND VOLTAGE	I/P-O/P:4000VAC							
	ISOLATION RESISTANCE	I/P-O/P:100M Ohms / 500VDC / 25°C / 70% RH							
	EMC EMISSION	Parameter	Standard					Test Level / Note	
		Conducted emission	BS EN/EN55032(CISPR32)/EN55011, FCC Part15, CNS15936, GB/T 9254.1-2021					Class B	
		Radiated emission	BS EN/EN55032(CISPR32)/EN55011, FCC Part15, CNS15936, GB/T 9254.1-2021					Class B	
	Harmonic current (Note.9)	BS EN/EN61000-3-2					Class A		
	EMC IMMUNITY	Parameter	Standard					Test Level / Note	
		ESD	BS EN/EN61000-4-2					Level 3, 15KV air; Level 2, 8KV contact	
		RF field susceptibility	BS EN/EN61000-4-3					Level 2, 3V/m	
EFT bursts		BS EN/EN61000-4-4					Level 2, 1KV		
Surge susceptibility		BS EN/EN61000-4-5					Level 3, 1KV/L-N		
Conducted susceptibility		BS EN/EN61000-4-6					Level 2, 3V		
Magnetic field immunity		BS EN/EN61000-4-8					Level 1, 1A/m		
Voltage dips, interruption	BS EN/EN61000-4-11					>95% dip 0.5 periods, 30% dip 25 periods, >95% interruptions 250 periods			
OTHERS	MTBF	682.2 Khrs min. MIL-HDBK-217F (25°C)		5852.4 Khrs min. Telcordia TR/SR-332(Bellcore) (25°C)					
	DIMENSION	62*30*65mm (L*W*H)							
	PACKING	MAIN BODY	196g; 60pcs/ 13.4Kg / 0.91CUFT for NGE65lxx/Uxx-P1J			211g; 45pcs/ 11.4Kg / 1.06CUFT for NGE65Exx-P1J			
AC PLUGS		Refer to Page 3							
DC OUTPUT CONNECTOR	PLUG	See page 6~7 ; Other type available by customer requested							
	CABLE	See page 6~7 ; Other type available by customer requested							
NOTE	<p>1.All parameters are specified at 230VAC input, rated load, 25°C 70% RH ambient.</p> <p>2.DC voltage: The output voltage set at point measure by plug terminal &amp; 50% load.</p> <p>3.Ripple &amp; noise are measured at 20MHz by using a 12" twisted pair terminated with a 0.1uf &amp; 47uf capacitor.</p> <p>4.Tolerance: includes set up tolerance, line regulation, load regulation.</p> <p>5.Line regulation is measured from low line to high line at rated load.</p> <p>6.Load regulation is measured from 0% to 100% rated load</p> <p>7.Derating may be needed under low input voltage. Please check the derating curve for more details.</p> <p>8.The power supply is considered as an independent unit, but the final equipment still need to re-confirm that the whole system complies with the EMC directives. For guidance on how to perform these EMC tests, please refer to "EMI testing of component power supplies." (as available on <a href="https://www.meanwell.com/Upload/PDF/EMI_statement_en.pdf">https://www.meanwell.com/Upload/PDF/EMI_statement_en.pdf</a>)</p> <p>9.Test harmonic current at 85% load.</p> <p>10.Design meet US DoE Level VII (from Docket number EERE-2020-BT-STD-0006).</p> <p>※ Product Liability Disclaimer : For detailed information, please refer to <a href="https://www.meanwell.com/serviceDisclaimer.aspx">https://www.meanwell.com/serviceDisclaimer.aspx</a></p>								



■ Interchangeable AC Plug Specifically for NGE12/18/30/45/65/90 (I-Type)

Model NO.	NGE65Ixx-P1J 					NGE65Exx-P1J 	NGE65Uxx-P1J 
AC plug	Interchangeable Type					Non-Interchangeable Type	
	EU 	US 	UK 	AU 	CN 		
Certificate							

■ AC Plugs Accessory (Sold Separately)

MW's order NO.	Per Pack	Per Bag	Per Carton	
	Photo for one unit	Q'Ty	Q'Ty	G.W.
AC PLUG-EU4		30pcs	300 pcs (10packs)	5.6Kg
AC PLUG-US4		30pcs	300 pcs (10packs)	5.3Kg
AC PLUG-UK4		30pcs	300 pcs (10packs)	7.1Kg
AC PLUG-AU4		30pcs	300 pcs (10packs)	5.3Kg
AC PLUG-CN4		30pcs	300 pcs (10packs)	5.4Kg
AC PLUG-MIX4		6*5 Types (EU4*1,US4*1) (UK4*1,AU4*1) CN4*1	60*5 Types =300 pcs (10packs)	5.74Kg

■ Interchangeable AC Plug Installation Steps (Convertible with I Type only)

Step1	Step2
	
<p>Slide in AC converter along the guided rail between the metal prongs until it is locked in (with a “click” sound).</p>	<p>Check if the new plug type is stable and correct before use.</p>

**Note:**

NGE65I main body unit and AC inlet plug should be ordered separately; It needs to be used along with any of the AC inlet plug (EU,US,UK,AU,CN), the AC plug can be changeable to EU,US,UK,AU,CN type with additional converter.

■ Derating Curve

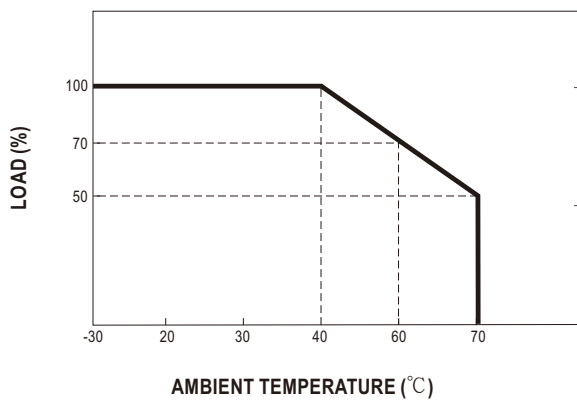

■ Static Characteristics

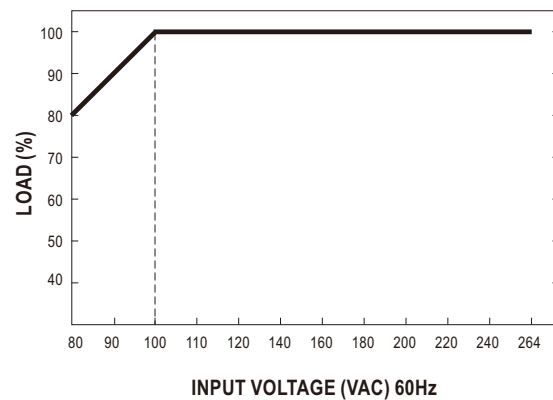

■ Mechanical Specification

※ Cable connection

Unit:mm

NGE65Ixx-P1J:

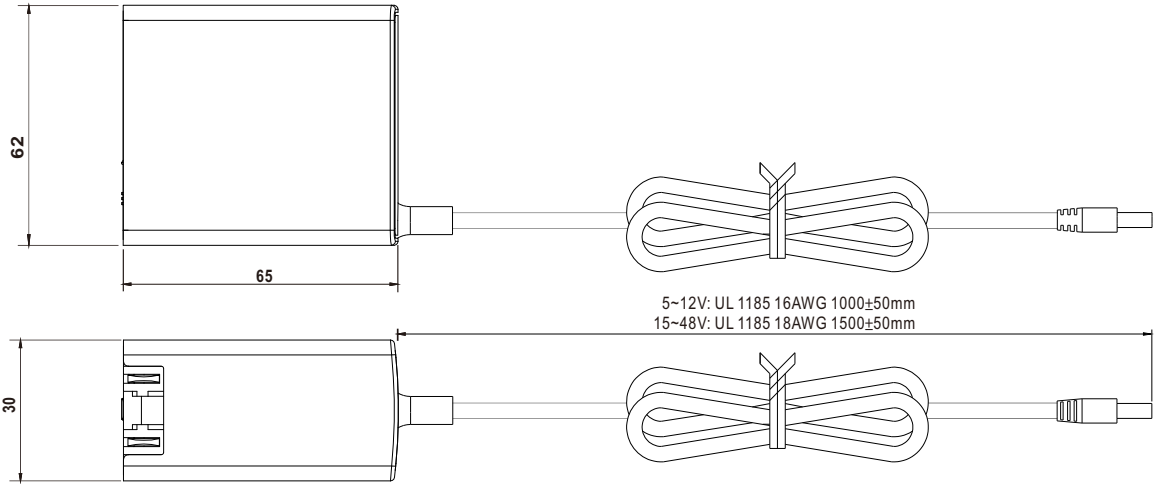

NGE65Exx-P1J:

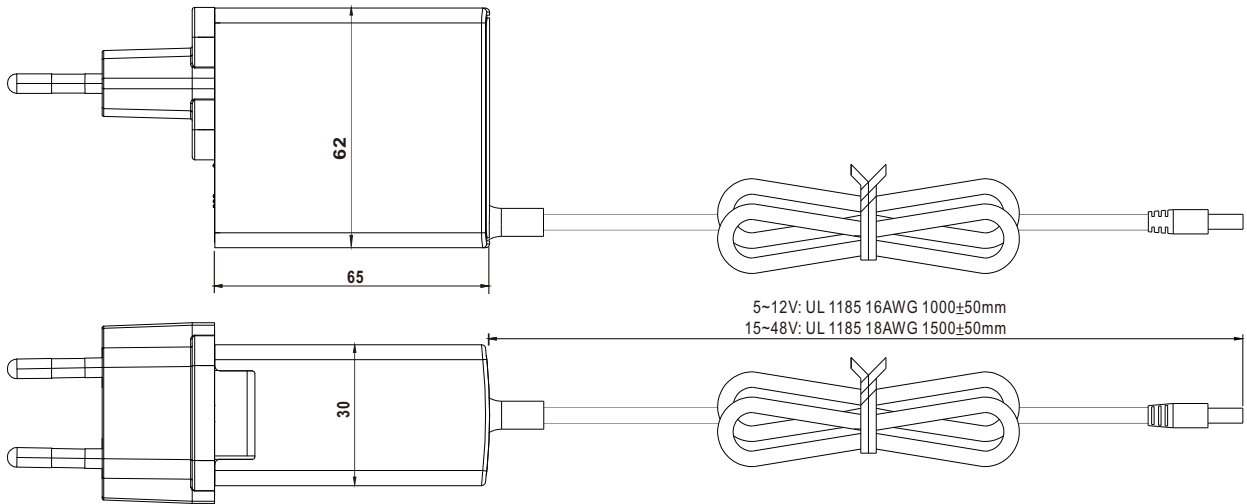

NGE65Uxx-P1J:

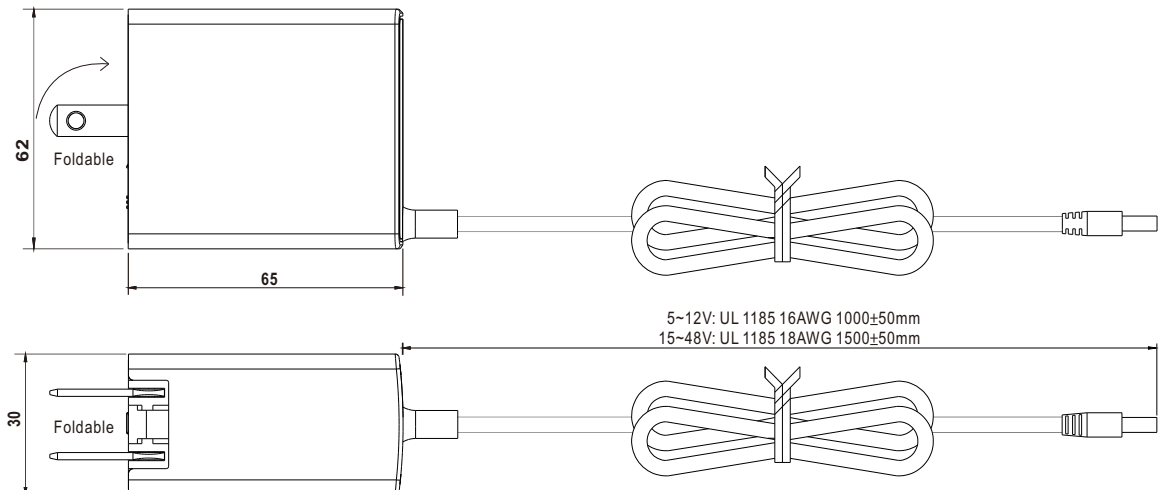

### DC Output Plug

Standard plug: P1J

Unit:mm

P1J	Pin Assignment
	Outside  Inside

DC plug changeable through:

- Customization of the standard part with an optional DC plug according to the table (MOQ applicable)
- Quick adapter accessory (sold separately without MOQ)



Please refer to below table and online selection guide : [https://www.meanwell.com/upload/pdf/DC\\_plug.pdf](https://www.meanwell.com/upload/pdf/DC_plug.pdf)

Example quick adapter accessory:

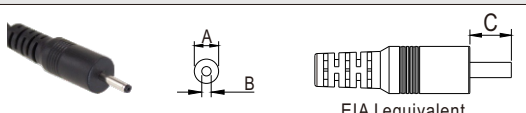
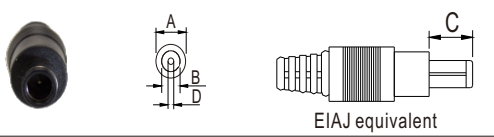
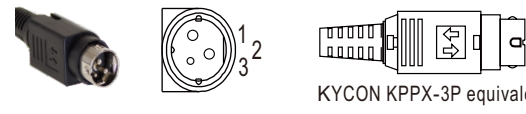

Optional DC plug: (Available in customized cable or quick adapter)

Tuning Fork Style	Type No.	A	B	C	Quick Adapter Accessory
		OD	ID	L	
	P1I (Straight)	5.5	2.1	9.5	Available (Current rating: 7.5A max.)
	P1L (Straight)	5.5	2.5	9.5	
	P1M (Straight)	5.5	2.5	11.0	
	P1IR (Right-angled)	5.5	2.1	9.5	
	P1JR (Right-angled)	5.5	2.1	11.0	
	P1LR (Right-angled)	5.5	2.5	9.5	
	P1MR (Right-angled)	5.5	2.5	11.0	
Barrel Style	Type No.	A	B	C	Quick Adapter Accessory
		OD	ID	L	
	P2I (Straight)	5.5	2.1	9.5	None
	P2J (Straight)	5.5	2.1	11.0	
	P2L (Straight)	5.5	2.5	9.5	
	P2M (Straight)	5.5	2.5	11.0	
	P2IR (Right-angled)	5.5	2.1	9.5	
	P2JR (Right-angled)	5.5	2.1	11.0	
	P2LR (Right-angled)	5.5	2.5	9.5	
P2MR (Right-angled)	5.5	2.5	11.0		
Lock Style	Type No.	A	B	C	Quick Adapter Accessory
		OD	ID	L	
	P2S(S761K)	5.53	2.03	12.06	None
	P2K(761K)	5.53	2.54	12.06	
	P2C(S760K)	5.53	2.03	9.52	
	P2D(760K)	5.53	2.54	9.52	

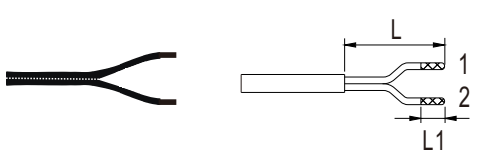
Min. Pin Style	Type No.	A	B	C	Quick Adapter Accessory	
		OD	ID	L		
 <p>EIAJ equivalent</p>	P3A	2.35	0.7	11.0	Available (Current rating: 5A max.)	
	P3B	4.0	1.7	11.0		
	P3C	4.75	1.7	11.0		
Center Pin Style	Type No.	A	B	C	D	Available (Current rating: 7.5A max.)
 <p>EIAJ equivalent</p>	P4A	5.5	3.4	11.0	1.0	
	P4B	6.5	4.4	11.0	1.4	
	P4C	7.4	5.1	11.0	0.6	
Min. DIN 3 Pin with Lock (male)	Type No.	Pin Assignment		Available (Current rating: 7.5A max.)		
 <p>KYCON KPPX-3P equivalent</p>	R6B	PIN No.	Output			
		1	+Vo			
		2	-Vo			
		3	+Vo			
Min. DIN 4 Pin with Lock (male)	Type No.	Pin Assignment		Available (Current rating: 7.5A max.)		
 <p>KYCON KPPX-4P equivalent</p>	R7B	PIN No.	Output			
		1	+Vo			
		2	-Vo			
		3	-Vo			
		4	+Vo			
Stripped and tinned leads	Type No.	Pin Assignment		None		
 <p>Length of Land L1 by request (MW's standard length, L: <u>25</u> mm, L1: <u>10</u> mm)</p>	by customer	PIN No.	Output			
		1 (Ribbed)	+Vo			
		2 (Letter)	-Vo			

■ **Installation Manual**

Please refer to : <http://www.meanwell.com/manual.html>