

**SERIES:** SWI15-N | **DESCRIPTION:** AC-DC POWER SUPPLY**FEATURES**

- compact design
- up to 15 W continuous power
- DoE Level VI compliant
- no load power consumption < 0.075 W
- universal input voltage range
- over voltage, over current, and short circuit protections
- UL/cUL and PSE safety approvals
- Class II construction
- IEC 62368 compliant



MODEL	output voltage	output current max	output power max	ripple and noise <sup>1</sup> max	efficiency level
	(Vdc)	(A)	(W)	(mVp-p)	
SWI15-5-N	5	2	10	50	VI
SWI15-9-N	9	1.4	12.6	90	VI
SWI15-12-N	12	1	12	100	VI
SWI15-15-N	15	1	15	100	VI
SWI15-24-N	24	0.63	15.1	100	VI

Notes: 1. At full load, nominal input, 20 MHz bandwidth oscilloscope, output terminated with 0.1  $\mu$ F ceramic and 10  $\mu$ F electrolytic capacitors.  
 2. All specifications are measured at Ta=25°C, nominal input voltage, and 75% rated output load unless otherwise specified.

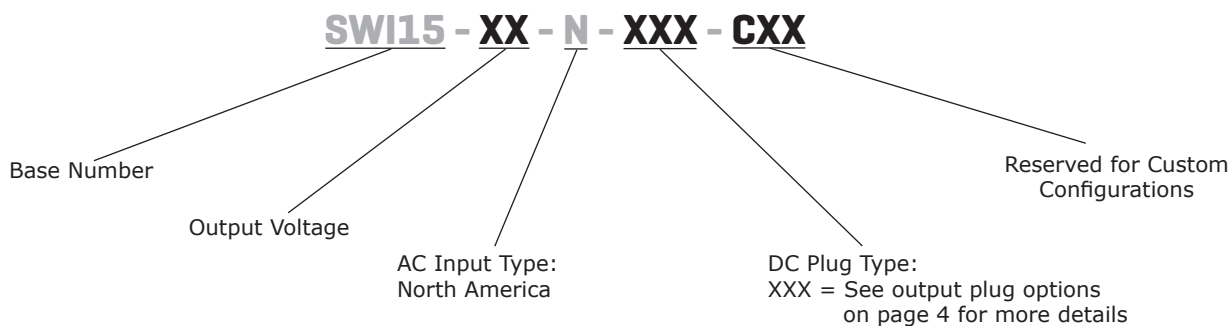
**PART NUMBER KEY**

## INPUT

parameter	conditions/description	min	typ	max	units
voltage		90		264	Vac
frequency		47		63	Hz
current				0.5	A
inrush current	at 240 Vac, 25°C, cold start			50	A
leakage current				0.25	mA
no load power consumption				0.075	W

## OUTPUT

parameter	conditions/description	min	typ	max	units
voltage set point accuracy	at 60% load		±2		%
line regulation	measured from 100~240 Vac, full load		±1		%
load regulation	measured from 60~100% load and 60~20% load 5 Vdc output model all other models		±4 ±2		% %
hold-up time	at 115 Vac		10		ms

## PROTECTIONS

parameter	conditions/description	min	typ	max	units
over voltage protection	hiccup mode, auto recovery 5 Vdc output model 9 Vdc output model 12 Vdc output model 15 Vdc output model 24 Vdc output model			7.14 12.1 15.8 19.5 28.4	Vdc Vdc Vdc Vdc Vdc
over current protection	hiccup mode, auto recovery	120		140	%
short circuit protection	continuous, hiccup mode, auto recovery				

## SAFETY & COMPLIANCE

parameter	conditions/description	min	typ	max	units
isolation voltage	input to output for 1 minute		3,000 4,242		Vac Vdc
isolation resistance	input to output	100			MΩ
safety marks	UL (North America), PSE (Japan), FCC (USA)				
safety approvals	62368: UL/cUL 60950: J (PSE)				
safety class	Class II				
EMI/EMC	FCC Part 15 Class B J55022				
MTBF	as per MIL-HDBK-217F at 115 Vac, full load, 25°C	330,000			hours
RoHS	2011/65/EU				

## ENVIRONMENTAL

parameter	conditions/description	min	typ	max	units
operating temperature		-20		40	°C
storage temperature		-20		85	°C

## MECHANICAL

parameter	conditions/description	min	typ	max	units
dimensions	71.00 x 33.00 x 48.40 (2.795 x 1.299 x 1.906 inches)				mm
inlet plug	North America				
weight			100		g

## MECHANICAL DRAWING

units: mm [inch]  
tolerance: X.XX: ±0.50 [±0.020]

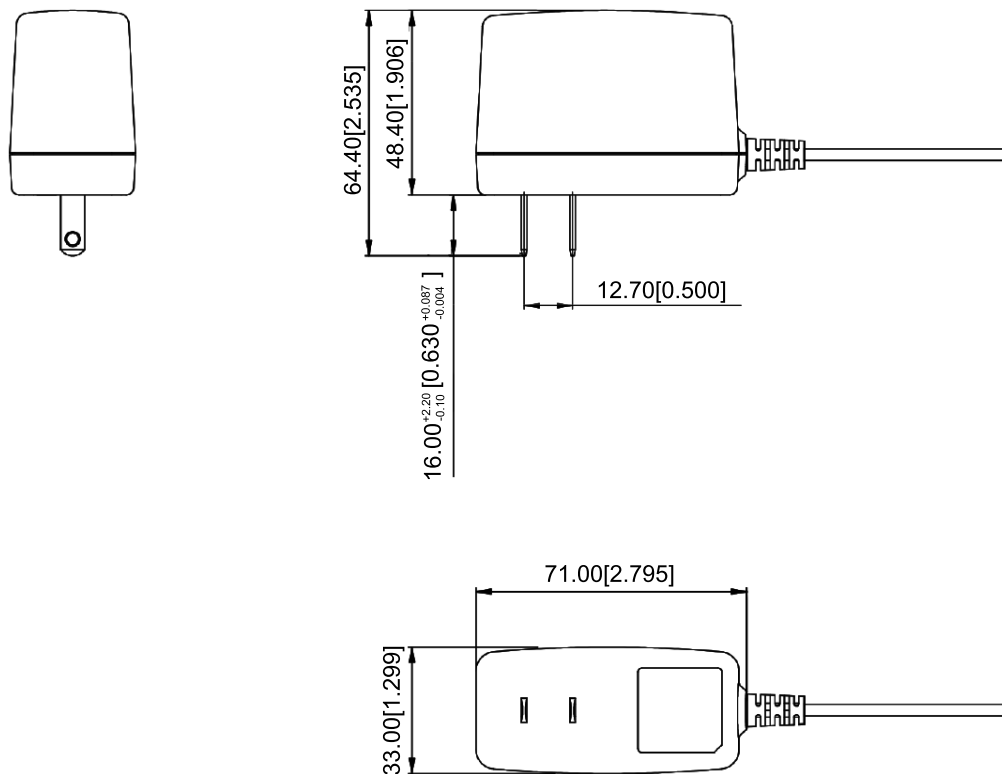

## DC CORD

units: mm

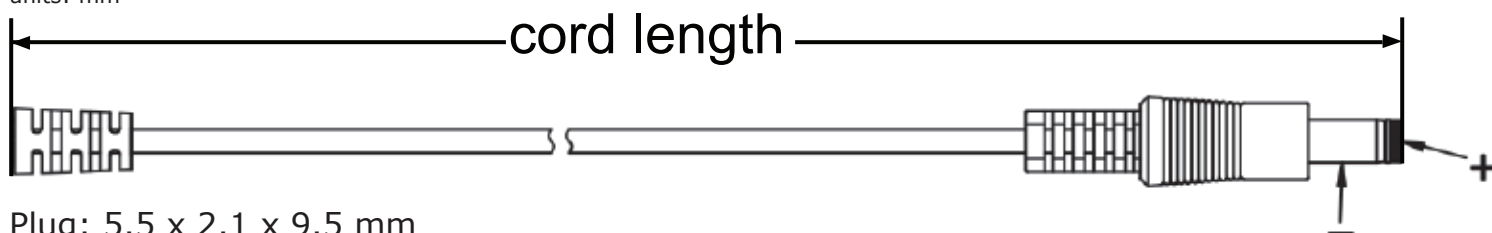



Plug: 5.5 x 2.1 x 9.5 mm

**Table 1**

MODEL NO.	CABLE	CORD LENGTH
SWI15-5-N	20 AWG	1,800 mm ±50
SWI15-9-N	18 AWG	1,800 mm ±50
SWI15-12-N	24 AWG	1,800 mm ±50
SWI15-15-N	24 AWG	1,800 mm ±50
SWI15-24-N	24 AWG	1,800 mm ±50

## DC PLUG TYPE PART NUMBER KEY

**XXX**

**Plug Polarity:**  
 P = Center Positive  
  
 N = Center Negative  

**Plug Code:**  
 X = Choose a code from the options below

**Plug Angle:**  
 "blank" = Straight  
 R = Right Angle

Plug Polarity		Code		Dimensions (mm)			Plug Angle	
Center Pos.	Center Neg.	Option	Type	A	B	C	Straight	Right
•	•	5	Standard	5.5	2.1	9.5	•	•
•	•	6	Standard	5.5	2.5	9.5	•	•
•	•	7	Standard	3.5	1.35	9.5	•	•
•	•	8	Standard	3.8	1.35	9.5	•	•
•	•	9	Standard	3.8	1.05	9.5	•	•
N/A	N/A	ST	Stripped & Tinned				N/A	N/A
N/A	N/A	MUB	USB	Micro USB Type B			•	N/A

Note: 1. Contact CUI for additional plug options

### Standard

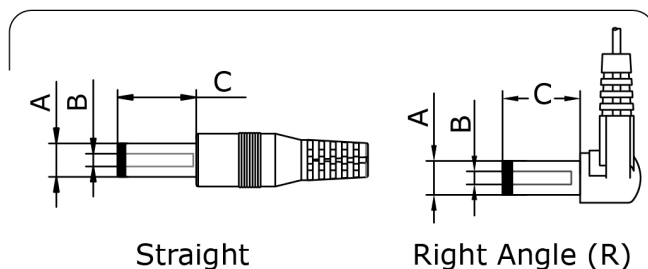

### USB

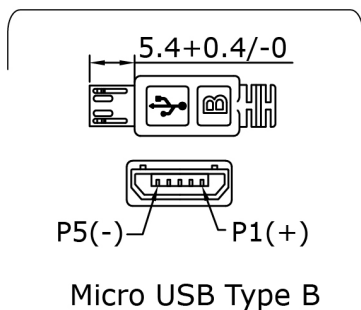

### Stripped & Tinned

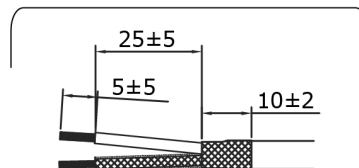

## REVISION HISTORY

rev.	description	date
1.0	initial release	03/08/2017
1.01	company logo updated	09/18/2020
1.02	updated safeties	10/02/2020
1.03	dc plug chart added	03/11/2021
1.04	safety marks updated	04/26/2021

The revision history provided is for informational purposes only and is believed to be accurate.



**CUI INC**

a bel group

**Headquarters**  
20050 SW 112th Ave.  
Tualatin, OR 97062  
**800.275.4899**

Fax 503.612.2383  
**cui.com**  
techsupport@cui.com

This device complies with part 15 of the FCC Rules. Operation is subject to the following two conditions:

- (1) This device may not cause harmful interference, and
- (2) this device must accept any interference received, including interference that may cause undesired operation.

CUI offers a one (1) year limited warranty. Complete warranty information is listed on our website.

CUI reserves the right to make changes to the product at any time without notice. Information provided by CUI is believed to be accurate and reliable. However, no responsibility is assumed by CUI for its use, nor for any infringements of patents or other rights of third parties which may result from its use.

CUI products are not authorized or warranted for use as critical components in equipment that requires an extremely high level of reliability. A critical component is any component of a life support device or system whose failure to perform can be reasonably expected to cause the failure of the life support device or system, or to affect its safety or effectiveness.