

**SERIES:** SMI6B | **DESCRIPTION:** AC-DC POWER SUPPLY

**FEATURES**

- DoE Level VI, CoC Tier 2 efficiency
- up to 6 W power
- compact design
- interchangeable AC blades
- universal input (90~264 Vac)
- single regulated output from 5~15 Vdc
- over voltage and short circuit protections
- UL/cUL, GS, RCM, CCC, PSE safety approvals
- certified to 62368-1
- custom designs available



MODEL	input voltage	input frequency	output voltage	output current	output power	ripple and noise <sup>1</sup>	efficiency level <sup>2</sup>		no load power consumption
	range (Vac)	range (Hz)	nom (Vdc)	max (A)	max (W)	max (mVp-p)	average <sup>3</sup> (%)	10% (%)	typ (W)
SMI6B-5	90 ~ 264	47 ~ 63	5	1.2	6.0	300	80.5	74.6	0.06
SMI6B-6	90 ~ 264	47 ~ 63	6	1.0	6.0	300	81.3	74.5	0.06
SMI6B-9	90 ~ 264	47 ~ 63	9	0.66	5.94	300	79.6	71.4	0.06
SMI6B-12	90 ~ 264	47 ~ 63	12	0.5	6.0	300	80.9	70.6	0.07
SMI6B-15	90 ~ 264	47 ~ 63	15	0.4	6.0	300	80.9	71.0	0.06

Notes: 1. At full load, 100-240 Vac input, 20 MHz bandwidth oscilloscope, output terminated with 0.1 µF and 10 µF capacitors.  
 2. CoC Tier 2 compliant  
 3. Average efficiency is measured at 25%, 50%, 75%, and 100% load.

**PART NUMBER KEY**

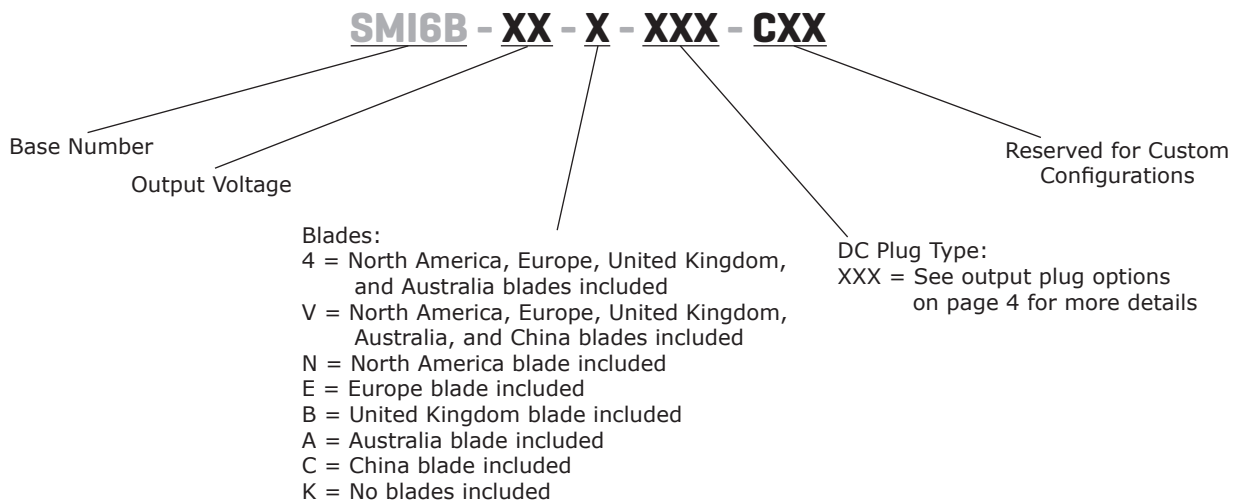

## INPUT

parameter	conditions/description	min	typ	max	units
voltage		90		264	Vac
frequency		47		63	Hz
current				0.2	A
leakage current	at nominal AC input and frequency			0.25	mA
no load power consumption	at 115/ 230 Vac, 60/50 Hz			0.075	W

## OUTPUT

parameter	conditions/description	min	typ	max	units
line regulation			±5		%
load regulation			±5		%
start-up time	at 115 Vac input			3	s
rise time	at 90~264 Vac input			100	ms
hold-up time	at nominal input	5			ms

## PROTECTIONS

parameter	conditions/description	min	typ	max	units
over current protection	output shut down, auto recovery				
	5 Vdc output models			1.8	A
	6 Vdc output models			1.6	A
	9, 12 Vdc output models			1.0	A
	15 Vdc output models			0.8	A
short circuit protection	output shut down, auto recovery				

## SAFETY & COMPLIANCE

parameter	conditions/description	min	typ	max	units
isolation voltage	input to output at 10 mA for 1 minute		3,000 4,242		Vac Vdc
safety approvals	UL/cUL, GS, RCM, CCC, PSE, UKCA				
EMI/EMC	FCC Part 15B Class B, CE				
MTBF	as per Telcordia SR-332, Issue 2 at 115/230 Vac, full load, 0~40°C	50,000			hours
RoHS	yes				

## ENVIRONMENTAL

parameter	conditions/description	min	typ	max	units
operating temperature		0		40	°C
storage temperature		-20		60	°C
operating humidity	non-condensing	20		85	%
storage humidity	non-condensing	5		95	%



## MECHANICAL

parameter	conditions/description	min	typ	max	units
dimensions	47 x 34.5 x 26.5				mm
inlet plug	interchangeable blades (North America, Europe, UK, Australia, China)				
ac blade clip type	hidden clip				
weight	5 Vdc output models (without interchangeable blades)		54		g
	all other models (without interchangeable blades)		50		g

## MECHANICAL DRAWING

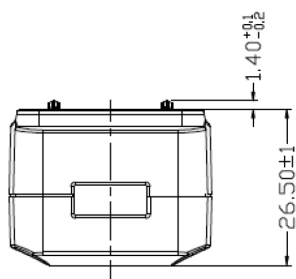
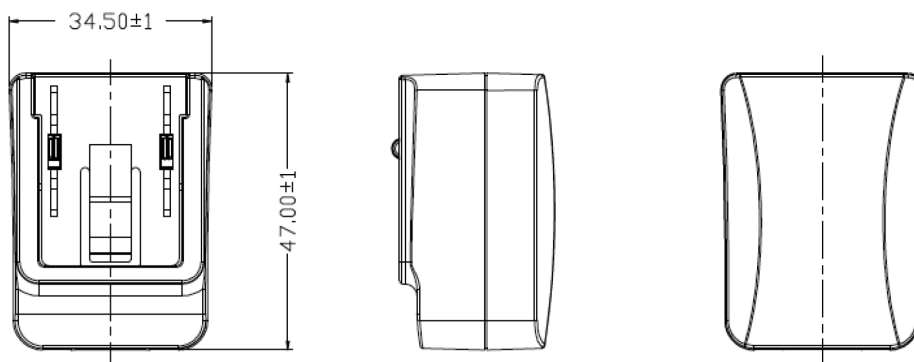
units: mm  
tolerance: ±1 mm

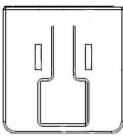
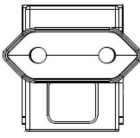
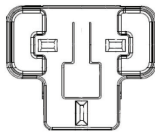

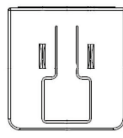
INTERCHANGEABLE BLADES					
BLADE DESIGNATOR	N	E	B	A	C
REGION	North America	Europe	UK	Australia	China
BLADE ACCESSORY	SMI-US-3	SMI-EU-3	SMI-UK-3	SMI-AU-3	SMI-CN-3
BLADE					

## DC CORD

units: mm



**Table 1**

MODEL NO.	CABLE	CORD LENGTH
SMI6B-5	UL2468, 22 AWG	1,530 mm ±50
SMI6B-6	UL2468, 22 AWG	1,530 mm ±50
SMI6B-9	UL2468, 24 AWG	1,530 mm ±50
SMI6B-12	UL2468, 24 AWG	1,530 mm ±50
SMI6B-15	UL2468, 24 AWG	1,530 mm ±50

## DC PLUG TYPE PART NUMBER KEY

**XXX**

**Plug Polarity:**  
 P = Center Positive  
  
 N = Center Negative

**Plug Code:**  
 X = Choose a code from the options below

**Plug Angle:**  
 "blank" = Straight  
 R = Right Angle

Plug Polarity		Code		Dimensions (mm)			Plug Angle	
Center Pos.	Center Neg.	Option	Type	A	B	C	Straight	Right
•	•	5	Standard	5.5	2.1	9.5	•	•
•	•	6	Standard	5.5	2.5	9.5	•	•
•	•	7	Standard	3.5	1.35	9.5	•	•
•	•	10	Locking <sup>2</sup>	5.5	2.1	9.5	•	N/A
•	•	11	Locking <sup>2</sup>	5.5	2.5	9.5	•	N/A
•	•	12	EIAJ-1	2.35	0.7	9.5	•	•
•	•	13	EIAJ-2	4.0	1.7	9.5	•	•
•	•	14	EIAJ-3	4.75	1.7	9.5	•	•
N/A	N/A	CUB	USB	USB Type C			•	N/A
N/A	N/A	MUB	USB	Micro USB Type B			•	N/A

Note: 1. Contact CUI for additional plug options  
 2. Maximum insertion depth is 10mm

### Standard

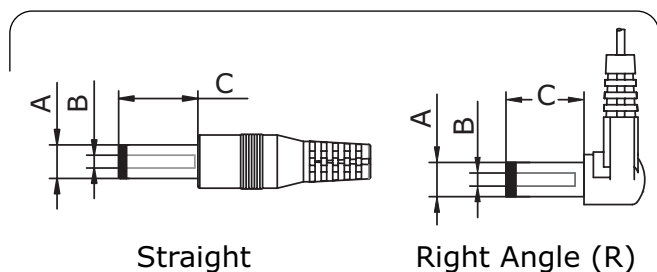

### EIAJ

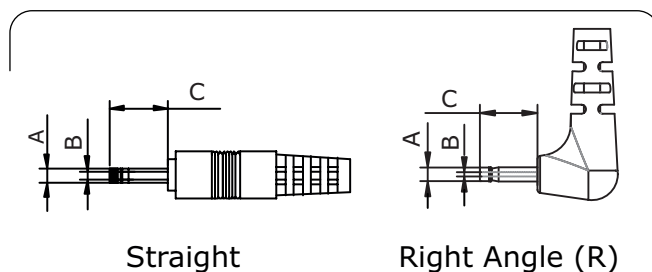

### Locking

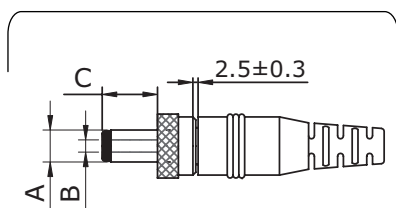

### USB

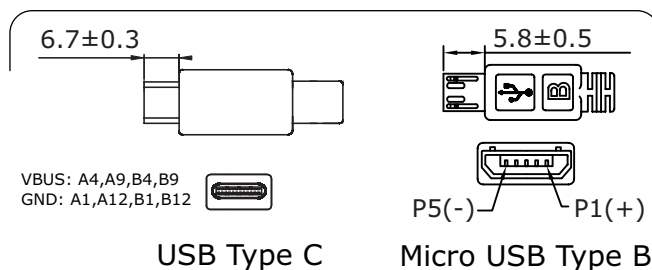

## REVISION HISTORY

rev.	description	date
1.0	initial release	06/04/2019
1.01	company logo updated	09/30/2020
1.02	model table updated	11/27/2020
1.03	UKCA added to spec	08/10/2021
1.04	plug polarity symbols updated	09/16/2021
1.05	dc plugs updated	04/24/2022
1.06	ac blade clip type added	06/23/2022

The revision history provided is for informational purposes only and is believed to be accurate.



# CUI INC

a bel group

**Headquarters**  
20050 SW 112th Ave.  
Tualatin, OR 97062  
**800.275.4899**

Fax 503.612.2383  
**cui.com**  
techsupport@cui.com

This device complies with part 15 of the FCC Rules. Operation is subject to the following two conditions:

- (1) This device may not cause harmful interference, and
- (2) this device must accept any interference received, including interference that may cause undesired operation.

CUI offers a one (1) year limited warranty. Complete warranty information is listed on our website.

CUI reserves the right to make changes to the product at any time without notice. Information provided by CUI is believed to be accurate and reliable. However, no responsibility is assumed by CUI for its use, nor for any infringements of patents or other rights of third parties which may result from its use.

CUI products are not authorized or warranted for use as critical components in equipment that requires an extremely high level of reliability. A critical component is any component of a life support device or system whose failure to perform can be reasonably expected to cause the failure of the life support device or system, or to affect its safety or effectiveness.