

**SERIES:** SDI90B-U | **DESCRIPTION:** AC-DC POWER SUPPLY

**FEATURES**

- level VI efficiency
- 90 W power
- universal input (90~264 Vac)
- over voltage, over current, short circuit, and over temperature protections
- UL/cUL, PSE, UKCA safety approvals
- certified to 62368-1 standards
- power factor correction
- -20 ~ 60/70 °C operation with derating
- 133.5 x 53.5 x 33.0 mm case size
- IEC320/C14 AC inlet
- custom designs available



| MODEL       | output voltage | output current max | output power max | ripple and noise <sup>1</sup> max | efficiency level |
|-------------|----------------|--------------------|------------------|-----------------------------------|------------------|
|             | (Vdc)          | (A)                | (W)              | (mVp-p)                           |                  |
| SDI90B-12-U | 12             | 7.50               | 90               | 180                               | VI               |
| SDI90B-15-U | 15             | 6.00               | 90               | 225                               | VI               |
| SDI90B-16-U | 16             | 5.63               | 90               | 240                               | VI               |
| SDI90B-18-U | 18             | 5.00               | 90               | 270                               | VI               |
| SDI90B-19-U | 19             | 4.70               | 90               | 228                               | VI               |
| SDI90B-24-U | 24             | 3.75               | 90               | 288                               | VI               |
| SDI90B-48-U | 48             | 1.88               | 90               | 576                               | VI               |
| SDI90B-56-U | 56             | 1.60               | 90               | 672                               | VI               |

Notes: 1. At full load, nominal input, 20 MHz bandwidth oscilloscope, each output terminated with 0.1 µF multilayer ceramic and 47 µF low ESR electrolytic capacitors.

**PART NUMBER KEY**

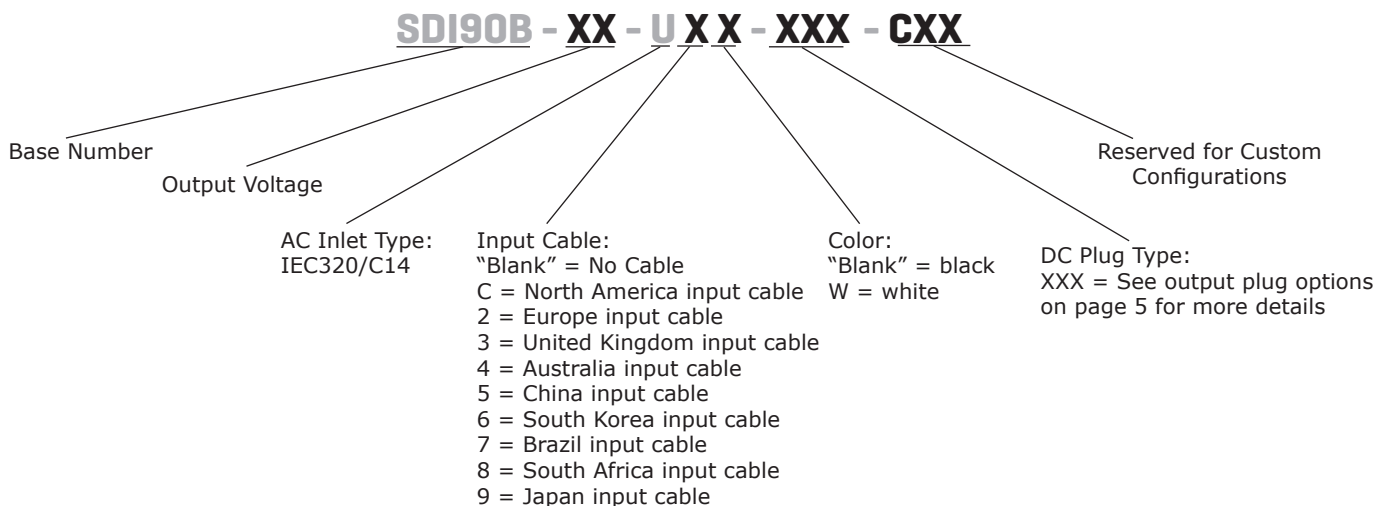

## INPUT

| parameter                 | conditions/description                  | min | typ     | max  | units |
|---------------------------|---|-----|---------|------|-------|
| voltage                   |   | 90  | 100~240 | 264  | Vac   |
| frequency                 |   | 47  | 50~60   | 63   | Hz    |
| current                   |   |     |         | 1.2  | A     |
| inrush current            | at 230 Vac, full load, 25°C, cold start |     |         | 80   | A     |
| leakage current           |   |     |         | 3.5  | mA    |
| power factor correction   | at 115 & 230 Vac, full load             | 0.9 |         |      |       |
| no load power consumption | at 115 & 230 Vac, no load               |     |         | 0.21 | W     |

## OUTPUT

| parameter  | conditions/description | min | typ | max | units |
|------------|------------------------|-----|-----|-----|-------|
| regulation |                        |     | ±5  |     | %     |

## PROTECTIONS

| parameter                   | conditions/description | min | typ | max | units |
|-----------------------------|------------------------|-----|-----|-----|-------|
| over voltage protection     | latch off (50% load)   |     |     | 150 | %     |
| over current protection     | auto recovery          |     |     | 180 | %     |
| short circuit protection    | auto recovery          |     |     |     |       |
| over temperature protection | auto recovery          |     |     |     |       |

## SAFETY & COMPLIANCE

| parameter         | conditions/description  | min     | typ            | max | units |
|-------------------|---|---------|----------------|-----|-------|
| isolation voltage | input to output at for 1 minute, 10 mA max<br>input to frame ground for 1 minute, 10 mA max |         | 3,000<br>1,770 |     | Vac   |
| safety approvals  | UL / CUL / PSE / UKCA   |         |                |     |       |
| EMI/EMC           | CE / FCC (conduction & radiation Class B)   |         |                |     |       |
| MTBF              | as per Telcordia SR-332, 25°C   | 300,000 |                |     | hrs   |
| RoHS              | yes   |         |                |     |       |

## ENVIRONMENTAL

| parameter             | conditions/description | min | typ | max | units |
|-----------------------|------------------------|-----|-----|-----|-------|
| operating temperature |                        | -20 |     | 40  | °C    |
| storage temperature   |                        | -20 |     | 80  | °C    |
| operating humidity    | non-condensing         | 20  |     | 80  | %     |
| storage humidity      | non-condensing         | 10  |     | 90  | %     |

## DERATING CURVES

### TEMPERATURE DERATING CURVE

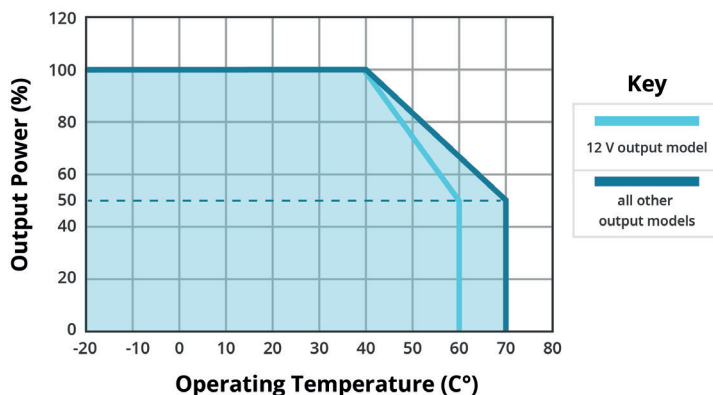

### INPUT VOLTAGE DERATING CURVE

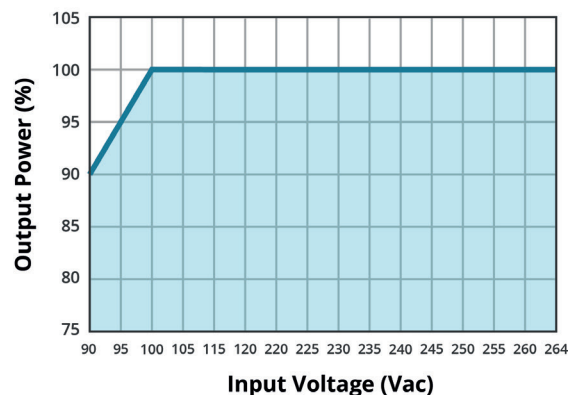

## MECHANICAL

| parameter  | conditions/description          | min | typ | max | units |
|------------|---------------------------------|-----|-----|-----|-------|
| dimensions | 133.5 (L) x 53.5 (W) x 33.0 (H) |     |     |     | mm    |
| inlet plug | IEC320/C14                      |     |     |     |       |
| weight     | 12V, 15V, 16V output models     |     | 330 |     | g     |
|            | all other output models         |     | 292 |     | g     |

## MECHANICAL DRAWING

units: mm  
tolerance: ±1.0 mm

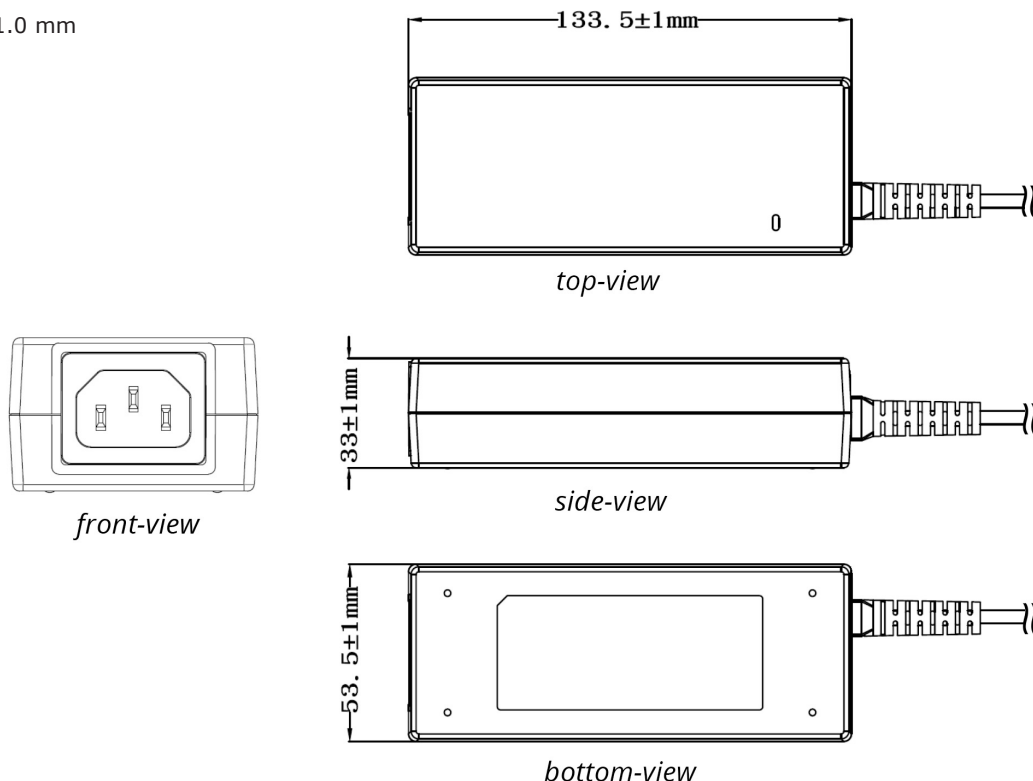

## DC CORD

units: mm

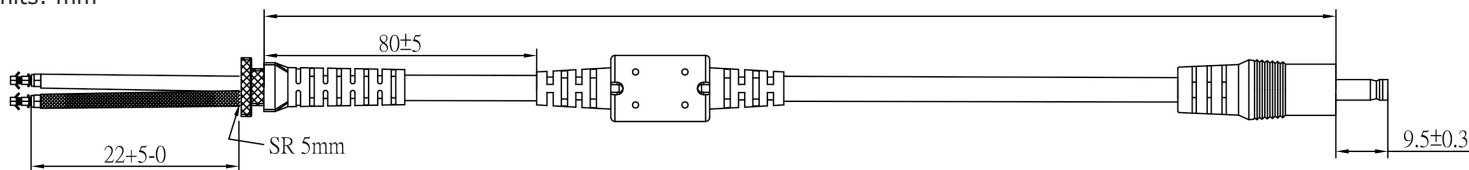

**Table 1**

| MODEL NO.   | CABLE          | CORD LENGTH  |
|-------------|----------------|--------------|
| SDI90B-12-U | UL1185, 16 AWG | 1,200 mm ±30 |
| SDI90B-15-U | UL1185, 16 AWG | 1,200 mm ±30 |
| SDI90B-16-U | UL1185, 16 AWG | 1,200 mm ±30 |
| SDI90B-18-U | UL1185, 18 AWG | 1,500 mm ±30 |
| SDI90B-19-U | UL1185, 18 AWG | 1,500 mm ±30 |
| SDI90B-24-U | UL1185, 18 AWG | 1,500 mm ±30 |
| SDI90B-48-U | UL1185, 20 AWG | 1,500 mm ±30 |
| SDI90B-56-U | UL1185, 20 AWG | 1,500 mm ±30 |

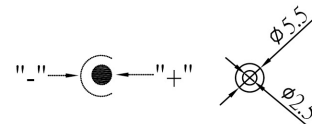

## AC CORD

units: mm

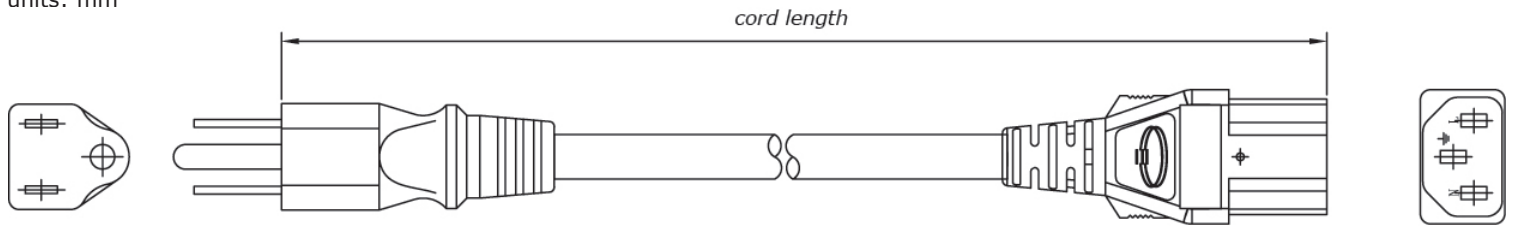

### NORTH AMERICA

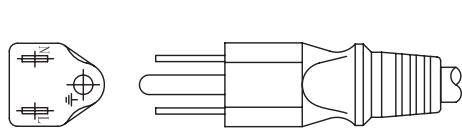

### EUROPE

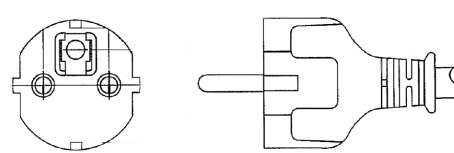

### UNITED KINGDOM

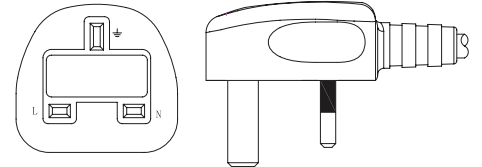

### AUSTRALIA



### CHINA

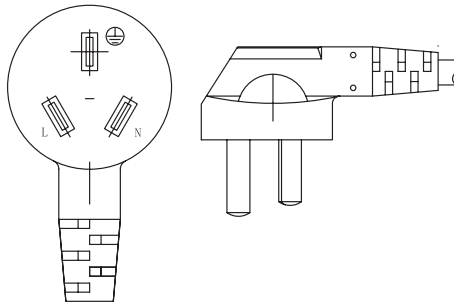

### SOUTH KOREA

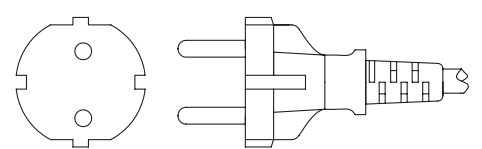

### BRAZIL

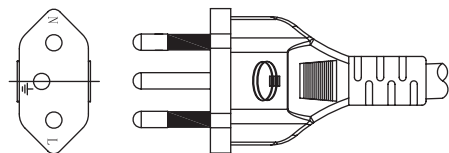

### SOUTH AFRICA

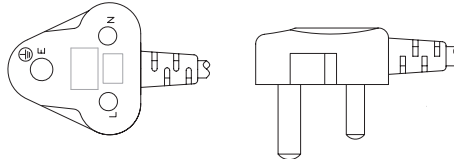

### JAPAN

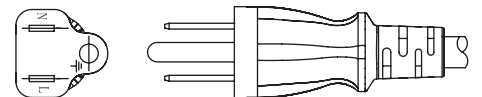

**Table 2**

| AC INPUT       | CORD LENGTH  |
|----------------|--------------|
| North America  | 1,830 mm ±30 |
| Europe         | 1,830 mm ±30 |
| United Kingdom | 1,830 mm ±30 |
| Australia      | 1,830 mm ±30 |
| China          | 1,830 mm ±30 |
| South Korea    | 1,830 mm ±50 |
| Brazil         | 1,830 mm ±30 |
| South Africa   | 1,830 mm ±50 |
| Japan          | 1,830 mm ±30 |

## DC PLUG TYPE PART NUMBER KEY

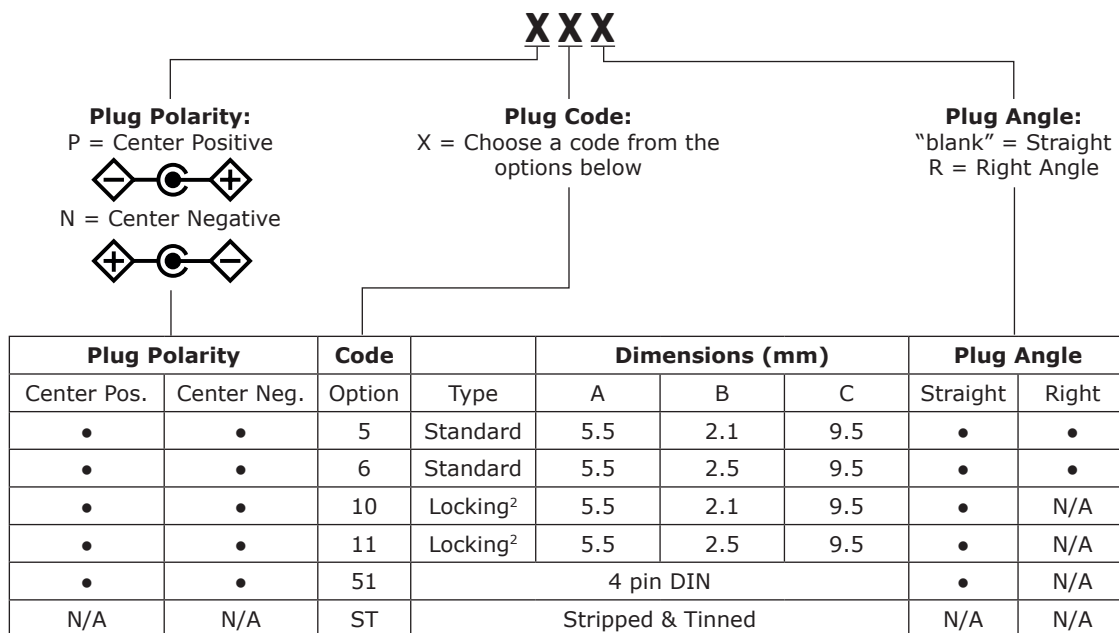

Note: 1. Contact CUI for additional plug options  
 2. Maximum insertion depth is 10mm  
 3. P5 plug is not available for the 12V output 7.5A model.

### Standard

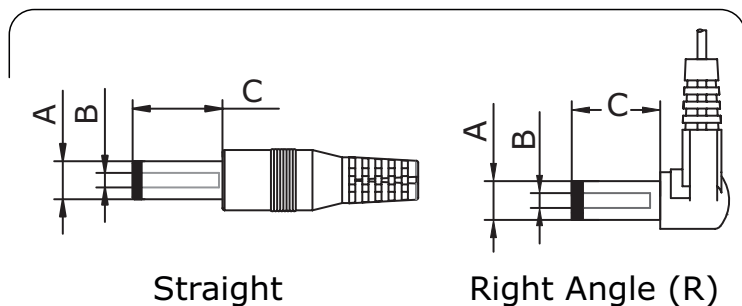

### Locking

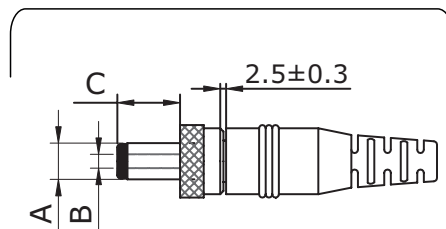

### 4 Pin DIN

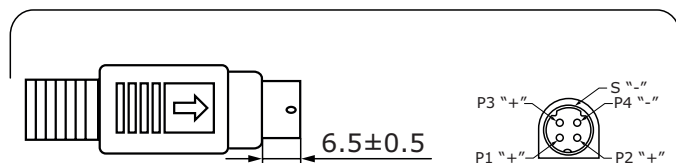

### Stripped & Tinned

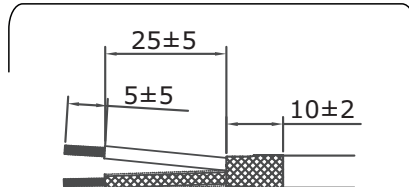

## REVISION HISTORY

---

| rev. | description     | date       |
|------|-----------------|------------|
| 1.0  | initial release | 11/23/2023 |

The revision history provided is for informational purposes only and is believed to be accurate.



**CUI INC**

a bel group

**Headquarters**  
20050 SW 112th Ave.  
Tualatin, OR 97062  
**800.275.4899**

Fax 503.612.2383  
**cui.com**  
techsupport@cui.com

This device complies with part 15 of the FCC Rules. Operation is subject to the following two conditions:

- (1) This device may not cause harmful interference, and
- (2) this device must accept any interference received, including interference that may cause undesired operation.

CUI offers a one (1) year limited warranty. Complete warranty information is listed on our website.

CUI reserves the right to make changes to the product at any time without notice. Information provided by CUI is believed to be accurate and reliable. However, no responsibility is assumed by CUI for its use, nor for any infringements of patents or other rights of third parties which may result from its use.

CUI products are not authorized or warranted for use as critical components in equipment that requires an extremely high level of reliability. A critical component is any component of a life support device or system whose failure to perform can be reasonably expected to cause the failure of the life support device or system, or to affect its safety or effectiveness.