

SERIES: EMSA 6W | **DESCRIPTION:** AC-DC POWER SUPPLY

FEATURES

- up to 6 W power
- interchangeable AC blades
- universal input (90~264 Vac)
- single regulated output from 5~15 V
- over voltage and short circuit protections
- UL/cUL, GS, RCM, CCC, PSE safety approvals
- level V efficiency
- custom designs available



MODEL	output voltage (Vdc)	output current max (A)	output power max (W)	ripple and noise ¹ max (mVp-p)	efficiency level
EMSA050120	5	1.2	6	150	V
EMSA090067	9	0.67	6	150	V
EMSA120050	12	0.50	6	120	V
EMSA150040	15	0.40	6	150	V

Notes: 1. At full load, 100 ~ 240 Vac input, 20 MHz bandwidth oscilloscope, each output terminated with 10 μ F aluminum electrolytic and 0.1 μ F ceramic capacitors.

PART NUMBER KEY

EMSA120050 X - XX - SZ - CXX

Base Number
example of 12 Vdc, 0.5 A

DC Plug Type

Factory Designation

Reserved for Custom Configurations

Blades:

"blank" = North American, European, United Kingdom, Australian, and China blades included

N = North American blade included

E = European blade included

B = United Kingdom blade included

A = Australian blade included

C = China blade included

K = No blades included

INPUT

parameter	conditions/description	min	typ	max	units
voltage		90		264	Vac
frequency		47		63	Hz
current				0.3	A RMS
inrush current	9 V output at 115 V ac, cold start			15	A
	9 V output at 230 V ac, cold start			30	A
	all other outputs: 115 V ac, cold start			30	A
	all other outputs: 230 V ac, cold start			60	A
no load power consumption			0.3	W	

OUTPUT

parameter	conditions/description	min	typ	max	units
line regulation			±3		%
load regulation			±5		%

PROTECTIONS

parameter	conditions/description
over voltage protection	protect through primary circuit IC
short circuit protection	output shut down and auto restart

SAFETY & COMPLIANCE

parameter	conditions/description	min	typ	max	units
isolation voltage	input to output at 10 mA for 1 minute			3,000	Vac
				4,242	Vdc
isolation resistance	input to output at 500 V dc	100			MΩ
safety approvals	UL 60950-1, EN 60950-1/IEC 60950-1, RCM, CCC, PSE				
EMI/EMC	FCC Part 15B, EN 55022B, CE				
leakage current	9 V output			0.25	mA
	all other outputs			0.1	mA
RoHS compliant	yes				

ENVIRONMENTAL

parameter	conditions/description	min	typ	max	units
operating temperature		0		40	°C
storage temperature		-10		70	°C
operating humidity		20		80	%
storage humidity		10		90	%

MECHANICAL

parameter	conditions/description	min	typ	max	units
dimensions	2.520 x 1.594 x 1.181 (64 x 40.5 x 30 mm)				inch
input plug	multi-blade (US, UK, Europe, Australia, China)				

MECHANICAL DRAWING

units: mm

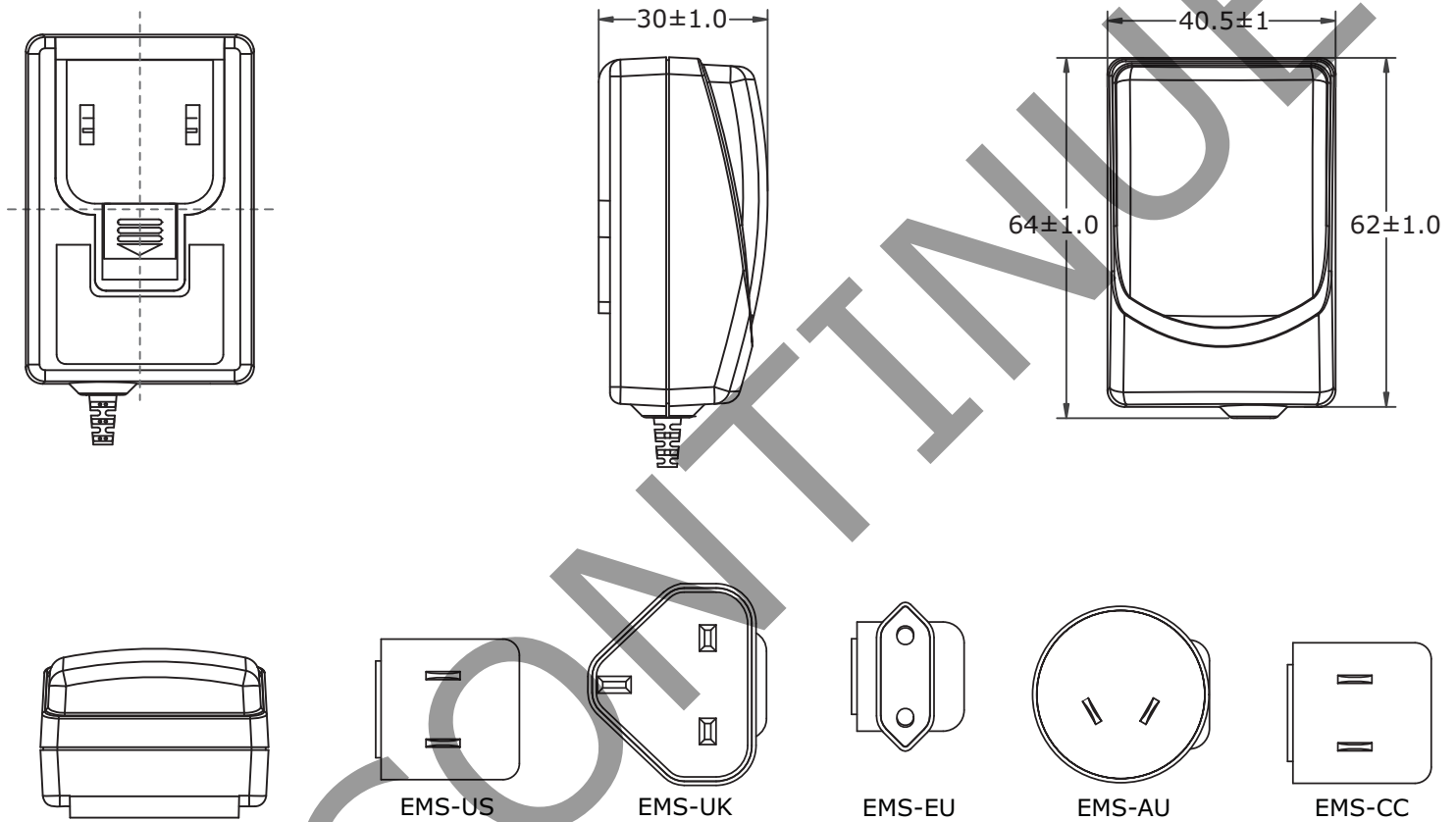

DC CORD

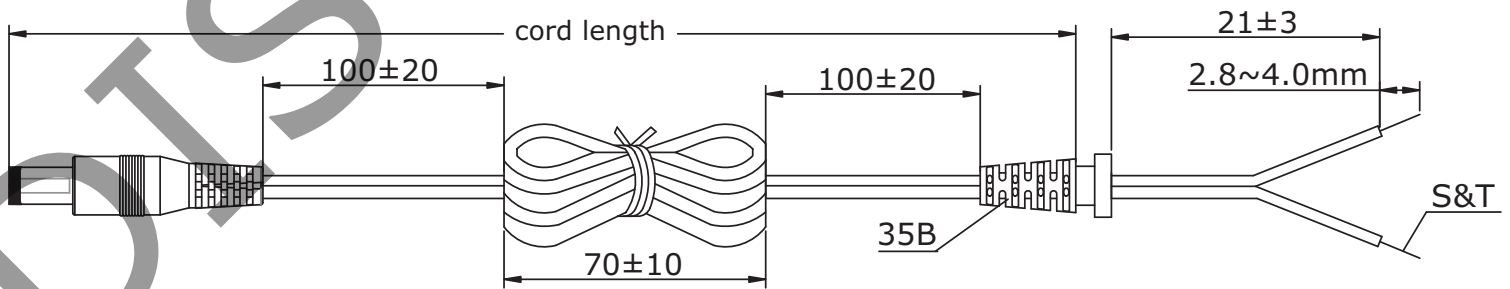

Black wire, white stripe: Positive

MODEL NO.	CABLE GAUGE	CORD LENGTH
EMSA050120	20 AWG	1530 ± 100
EMSA090067	22 AWG	1530 ± 100
EMSA120050	22 AWG	1530 ± 100
EMSA150040	22 AWG	1530 ± 100

OUTPUT PLUG OPTIONS

3.5 mm Phono Plug

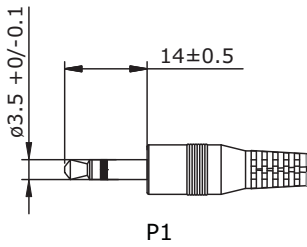

P1

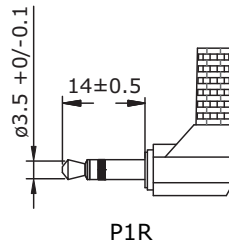

P1R

*Tip positive

Standard DC Plug

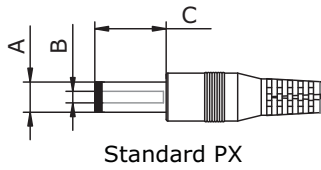

Standard PX

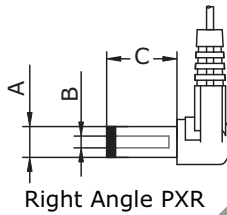

Right Angle PXR

	A	B	C	Unit
P5/P5R	5.5	2.1	9.5	mm
P6/P6R	5.5	2.5	9.5	mm
P7/P7R	3.5	1.35	9.5	mm
P8/P8R	3.8	1.35	9.5	mm
P9/P9R	3.8	1.05	9.5	mm

Locking DC Plug

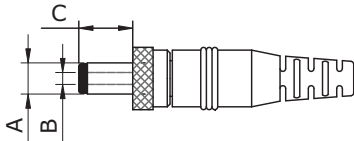

	A	B	C	Unit
P10	5.5	2.1	9.5	mm
P11	5.5	2.5	9.5	mm

EIAJ Plugs

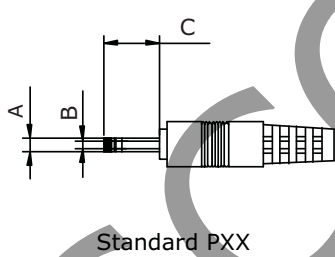

Standard PXX

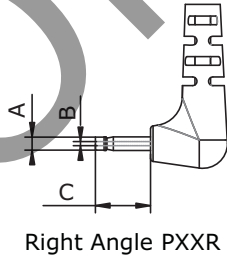

Right Angle PXXR

	EIAJ	A	B	C	D	Unit
P12/P12R	EIAJ-1	2.35	0.7	9.5	NA	mm
P13/P13R	EIAJ-2	4.0	1.7	9.5	5.0	mm
P14/P14R	EIAJ-3	4.75	1.7	9.5	5.0	mm

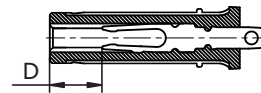

Stripped and Tinned

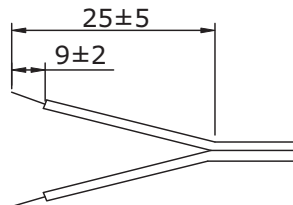

DC PLUG TYPE

ST
Stripped and Tinned

PXXXX

Plug Type Plug Angle: "Blank" = Standard
R = Right Angle Plug Polarity: "Blank" = N/A
P = Center Positive N = Center Negative

*Contact CUI for additional output plug options.

REVISION HISTORY

rev.	description	date
1.0	initial release	07/28/2010
1.01	new template applied	08/08/2011
1.02	PSE safety approval added	09/07/2011
1.03	updated P7/P7R B dimension	03/23/2012
1.04	V-Infinity branding removed, safety data updated	08/21/2012

The revision history provided is for informational purposes only and is believed to be accurate.

This device complies with part 15 of the FCC Rules. Operation is subject to the following two conditions:

- (1) This device may not cause harmful interference, and
- (2) this device must accept any interference received, including interference that may cause undesired operation.

CUI offers a one (1) year limited warranty. Complete warranty information is listed on our website.

CUI reserves the right to make changes to the product at any time without notice. Information provided by CUI is believed to be accurate and reliable. However, no responsibility is assumed by CUI for its use, nor for any infringements of patents or other rights of third parties which may result from its use.

CUI products are not authorized or warranted for use as critical components in equipment that requires an extremely high level of reliability. A critical component is any component of a life support device or system whose failure to perform can be reasonably expected to cause the failure of the life support device or system, or to affect its safety or effectiveness.



Headquarters
20050 SW 112th Ave.
Tualatin, OR 97062
800.275.4899

Fax 503.612.2383
cui.com
techsupport@cui.com