

Click to
ORDER
samples

AMEL60-277HAVZ

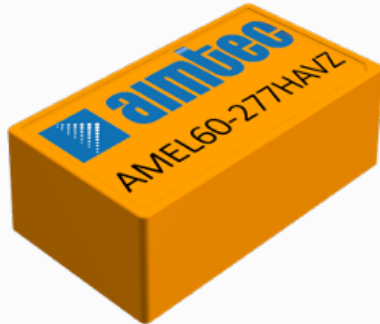

Encapsulated

The AMEL60-277HAVZ series is an efficient 60W AC-DC power supply module. Offering a wide commercial input voltage range of 85-305VAC, output voltage ranges from 5-48V, low power consumption, high efficiency, high reliability and safer isolation.

This new series offers great operating temperatures, from -40°C to 85°C with full power up to 50°C and features an isolation of 4200VAC with OVCIII rating for improved reliability and system safety. Additionally, it has 2000m-5000m operational altitude de rating. Furthermore, a high MTBF of 500,000h, output short circuit protection (OSCP), output over-current protection (OCP) and an output over-voltage protection (OVP) come standard with the series.

The AMEL60-277HAVZ is great for grid power, industrial instrumentation and controls, communication, and civil applications.

Features

- Universal Input: 85 - 305VAC/100 - 430VDC
- Operating Temp: -40 °C to +85 °C
- High isolation voltage: 4200VAC
- Low ripple & noise, 150mV(p-p) max.
- Output short circuit, over-current, over-voltage protection
- Low no-load power consumption of 0.3W
- Efficiency up to 91%
- OVC III(EN62477, 5000m altitude)
- Designed to meet : UL/EN/BS EN 62368-1
- Designed to meet : IEC 62368-1, EN 61558-1, IEC/EN 60335-1, IEC/EN 62477-1 standards



Summary

AMEL60-277HAVZ

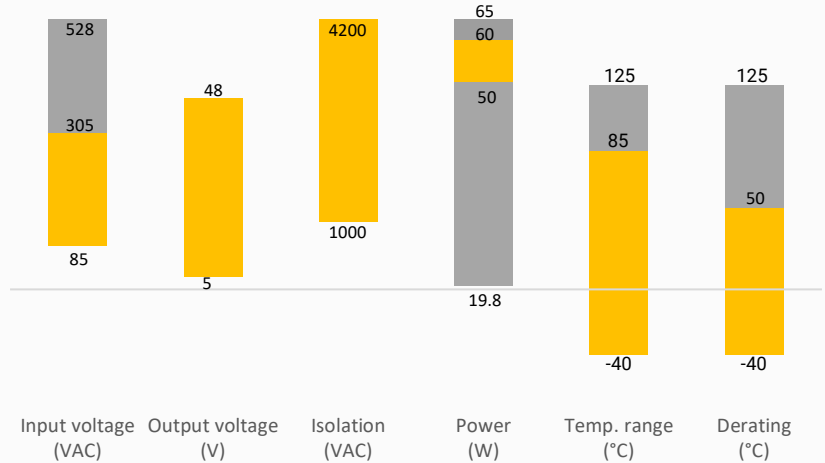

Training



Product Training Video
(coming soon)



Press Release

Coming Soon!

Application Notes

Applications



Power Grid



Industrial



Telecom

Models & Specifications

Single Output							
Model	Input Voltage (VAC/Hz)	Input Voltage (VDC)	Max Output wattage (W)	Output Voltage (V)	Output Current max (A)	Maximum capacitive load (μF)	Efficiency @ 230VAC Typ. (%)
AMEL60-5S277HAVZ	85-305/47-440	100-430	50	5	10	20000	89
AMEL60-12S277HAVZ	85-305/47-440	100-430	60	12	5	5000	91
AMEL60-15S277HAVZ	85-305/47-440	100-430	60	15	4	3000	90
AMEL60-24S277HAVZ	85-305/47-440	100-430	60	24	2.5	1800	90
AMEL60-48S277HAVZ	85-305/47-440	100-430	60	48	1.25	470	91

Input Specifications						
Parameters	Conditions	Typical	Minimum	Maximum	Units	
Input current	115VAC			1.8	A	
	230VAC			1	A	
Inrush current	115VAC	30			A	
	230VAC	60			A	
Leakage	277VAC, 50Hz			0.25	mA RMS	
Input Frequency			47	63	Hz	
Input Voltage Range	AC Input		85	305	VAC	
	DC Input		100	430	VDC	
Hot Plug	Unavailable					
Recommended External I/p Fuse	3.15A/300V, Slow blow, required					

Output Specifications				
Parameters	Conditions	Typical	Maximum	Units
Voltage accuracy		±2		%
Line regulation	Full load	±1		%
Load Regulation	0%-100% load	±1.5		%
Ripple & Noise*	20MHz bandwidth (peak to peak value)	80	150	mV p-p
Hold up time	115VAC	8		ms
	230VAC	65		ms

* Ripple and Noise are measured at 20MHz bandwidth with a 10μF electrolytic capacitor and a 1μF ceramic capacitor. Please refer to the application note for specific details. Note: *The "parallel cable" method is used for ripple and noise test, output parallel 10uF electrolytic capacitor and 1uF ceramic capacitor, please refer to AC-DC Converter Application Notes for specific information;

Isolation Specification				
Parameters	Conditions	Typical	Maximum	Units
Tested I/O voltage	60 sec, leakage \leq 5mA	4200		VAC
Resistance	500VDC	>100		M Ω

General Specifications					
Parameters	Conditions	Typical	Minimum	Maximum	Units
Protection class	Class II				
Oversoltage category	OVC III				
Over current protection	Auto recovery	\geq 140			% of Iout
Over voltage protection	5Vout, voltage clamp, hiccup			9	VDC
	12Vout, voltage clamp, hiccup			16	VDC
	15Vout, voltage clamp, hiccup			25	VDC
	24Vout, voltage clamp, hiccup			35	VDC
	48Vout, voltage clamp, hiccup			60	VDC
Short circuit protection	Hiccup, Continuous, Auto recovery				
Operating temperature	See derating graph	-40 to +85			$^{\circ}$ C
Storage temperature		-40 to +85			$^{\circ}$ C
Wave soldering temperature	Duration 5 - 10s	260 \pm 5			$^{\circ}$ C
Manual soldering temperature	Duration 3 - 5s	360 \pm 10			$^{\circ}$ C
No-load power consumption	230VAC	0.3		0.45	W
Power Derating	-40 $^{\circ}$ C to -25 $^{\circ}$ C, 85VAC to 200VAC Input		3.33		%/ $^{\circ}$ C
	-40 $^{\circ}$ C to -25 $^{\circ}$ C, 200VAC to 305VAC Input		1.33		
	+40 $^{\circ}$ C to +70 $^{\circ}$ C(5VDC Output)		1.5		
	+70 $^{\circ}$ C to +85 $^{\circ}$ C		2		
	+45 $^{\circ}$ C to +70 $^{\circ}$ C (85-165 VAC input,12/15/24/48 VDC output)		1.8		%/ $^{\circ}$ C
	+50 $^{\circ}$ C to +70 $^{\circ}$ C (\geq 165 VAC input,12/15/24/48 VDC output)		2.25		%/ $^{\circ}$ C
	85VAC to 100VAC		1.33		%/VAC
	277VAC to 305VAC		0.72		%/VAC
	2000 - 5000m		6.67		%/km
Temperature coefficient		\pm 0.02			%/ $^{\circ}$ C
Cooling	Free air convection				
Humidity	Non-condensing			95	% RH
Case material	Black Plastic (flammability to UL 94V-0)				
Weight	PCB mountable models	130			g
Dimensions (L x W x H)	PCB mountable models	2.76 x 1.88x1.06 (inches), 70 x 48.00 x 27.00 (mm)			
MTBF	> 500,000 hrs (MIL-HDBK - 217F, t= $+25^{\circ}$ C)				
NOTE: All specifications in this datasheet are measured at an ambient temperature of 25 $^{\circ}$ C, humidity<75%, nominal input voltage and at rated output load unless otherwise specified.					

Safety Specifications

Parameters

Agency approvals	Designed to meet UL/EN/BS EN 62368-1	
Standards	Information technology Equipment	Designed to meet IEC 62368-1, IEC/EN60335-1/62477-1, EN61558-1
	EMC - Conducted and radiated emission	CISPR32 / EN55032, class B
	Electrostatic Discharge Immunity	IEC/EN 61000-4-2 Contact ± 6 KV, Air ± 8 KV, Criteria A
	RF, Electromagnetic Field Immunity	IEC/EN 61000-4-3 10V/m, Criteria A
	Electrical Fast Transient/Burst Immunity	IEC/EN 61000-4-4 ± 2 KV, Criteria A IEC/EN 61000-4-4 ± 4 KV, Criteria A with the recommended EMC circuit
	Surge Immunity	IEC/EN 61000-4-5 L-L ± 2 KV, Criteria A IEC/EN 61000-4-5 L-L ± 2 KV, L-GND ± 4 KV, Criteria A with the recommended EMC circuit
	RF, Conducted Disturbance Immunity	IEC/EN 61000-4-6 10Vr.m.s, Criteria A
	Voltage dips, Short Interruptions Immunity	IEC/EN 61000-4-11 0%, 70%, Criteria B

Derating

Thermal Derating for all 5VDC model

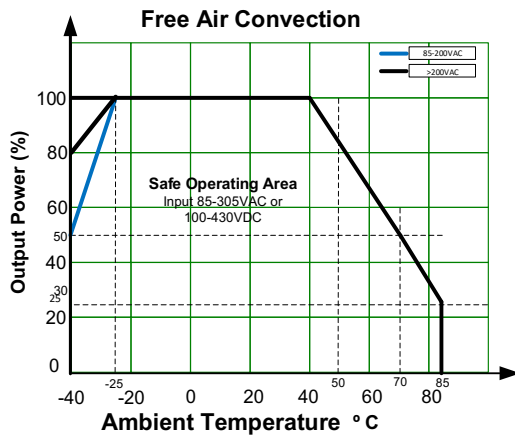

Thermal Derating for all other models

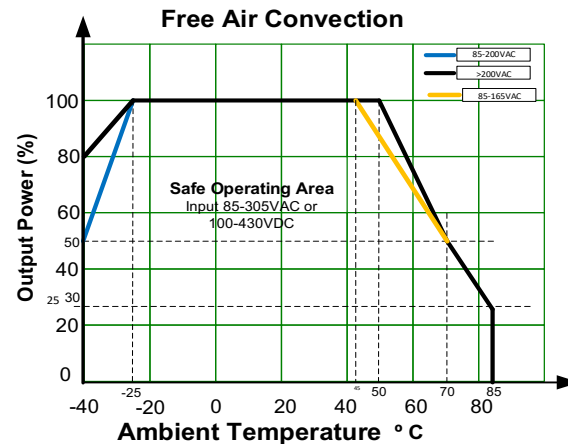

Altitude Derating

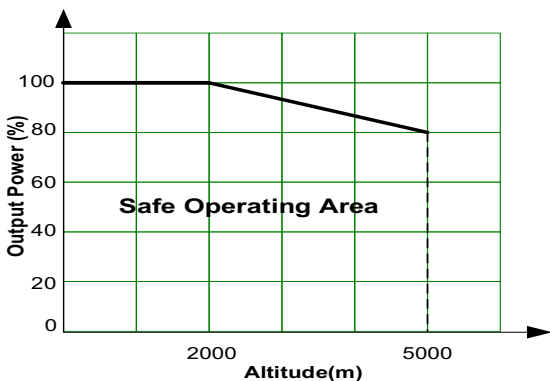

Free Air Convection at 25°C

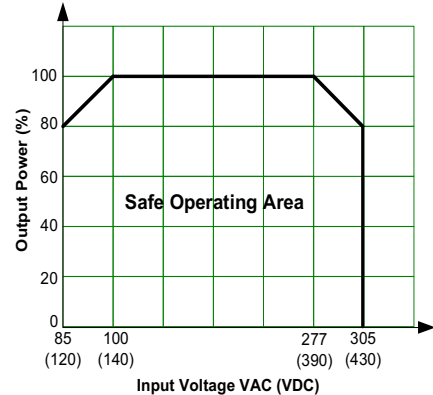

Efficiency curves

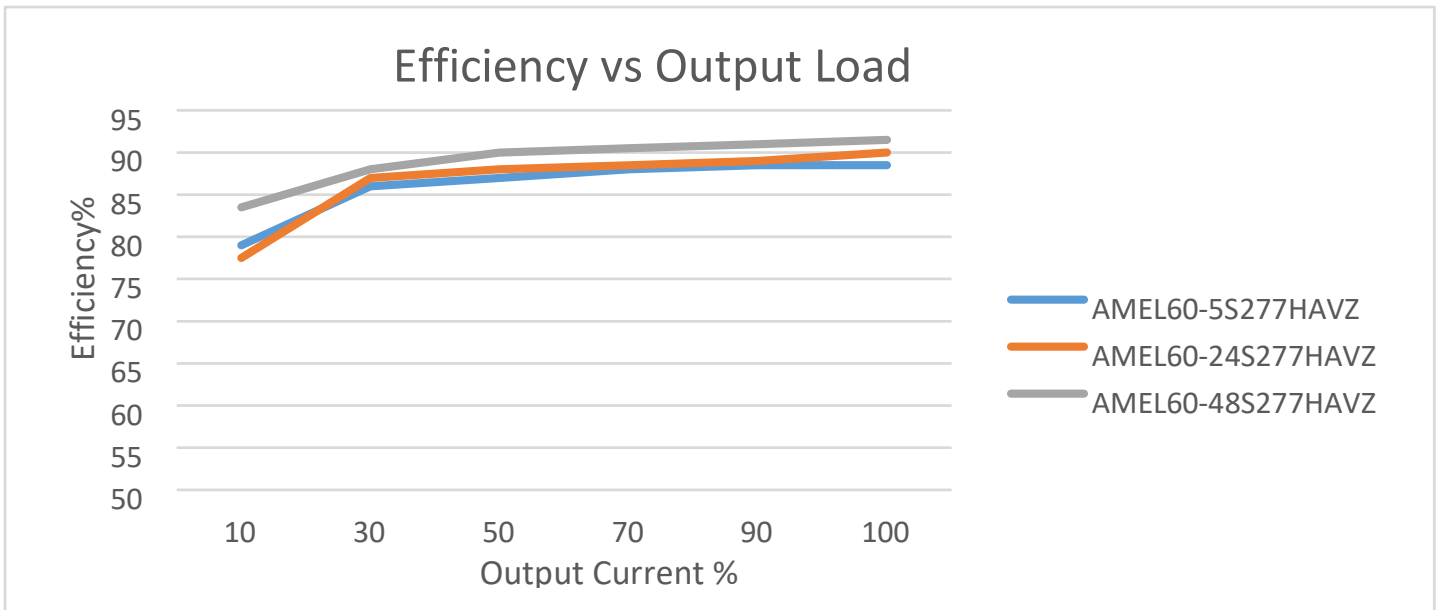
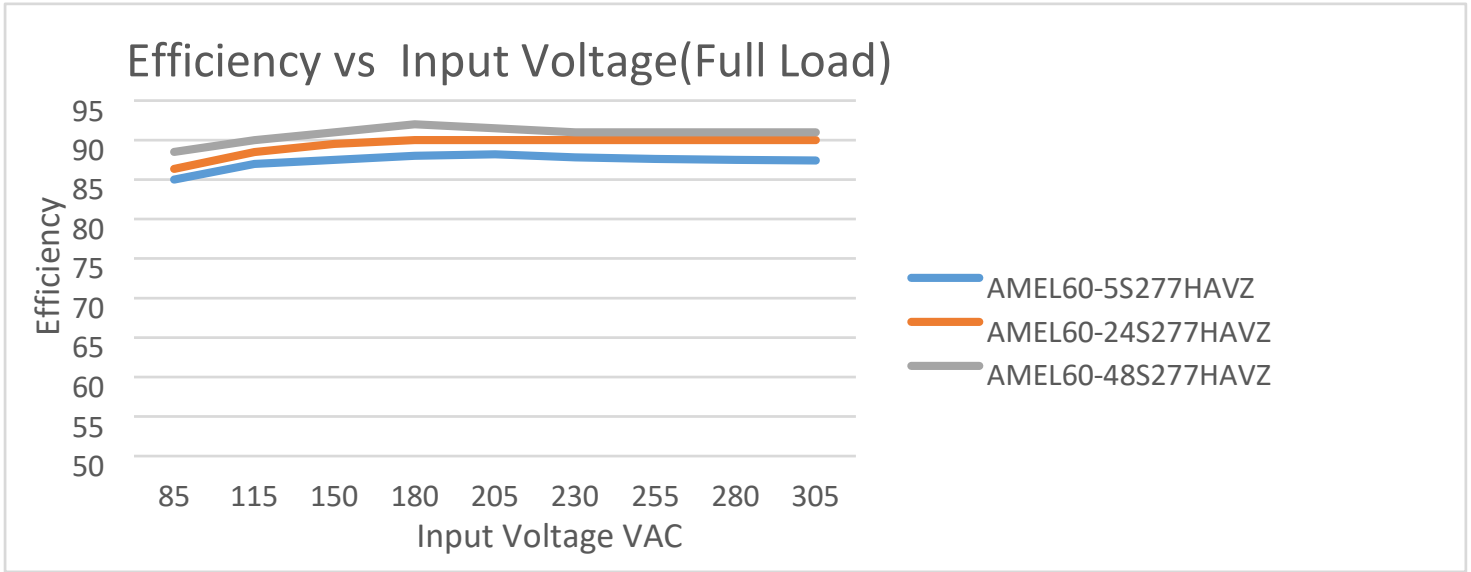

Typical Application Circuit

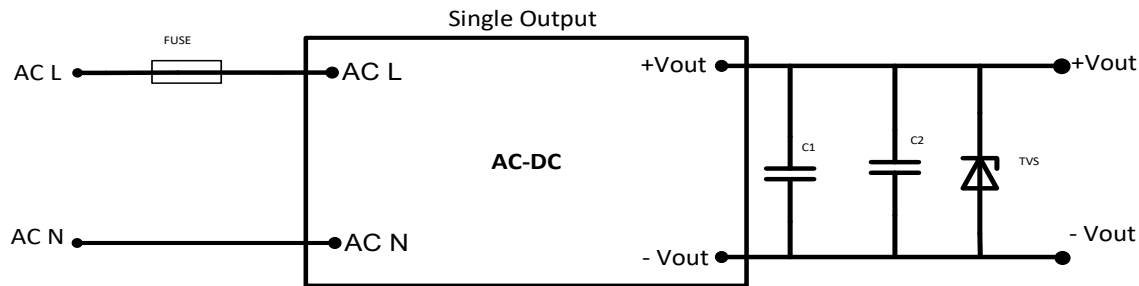

Model	C1	C2	TVS
5Vout	1 μ F/50V	470 μ F/16V	10V
12Vout	1 μ F/50V	330 μ F/25V	20V
15Vout	1 μ F/50V	330 μ F/25V	30V
24Vout	1 μ F/50V	220 μ F/35V	40V
48Vout	1 μ F/100V	100 μ F/63V	60V

For filtering components:

The C2 capacitor is recommended to use electrolytic type with high frequency and low ESR rating. The C1 capacitor is recommended to use ceramic type for filtering high-frequency noise.

Recommended EMC Circuit

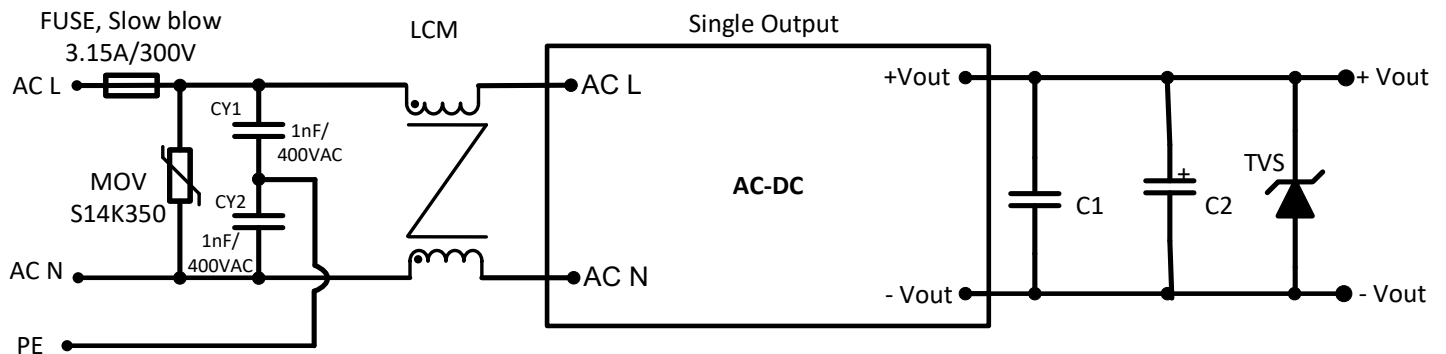

Dimensions

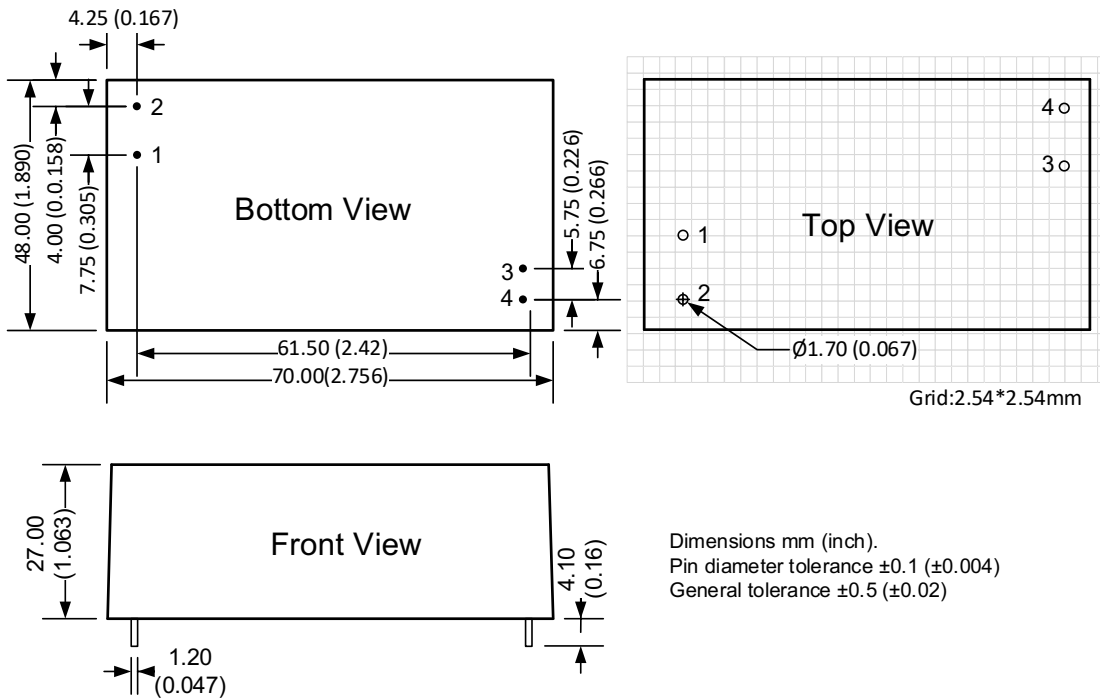

Pin Output Specifications	
Pin	Function
1	AC Input (N)
2	AC Input (L)
3	-V Output
4	+V Output

NOTE: **1.** Datasheets are updated as needed and as such, specifications are subject to change without notice. Once printed or downloaded, datasheets are no longer controlled by Aimtec; refer to www.aimtec.com for the most current product specifications. **2.** Product labels shown, including safety agency certifications on labels, may vary based on the date manufactured. **3.** Mechanical drawings and specifications are for reference only. **4.** All specifications are measured at an ambient temperature of 25°C, humidity < 75%, nominal input voltage and at rated output load unless otherwise specified. **5.** Aimtec may not have conducted destructive testing or chemical analysis on all internal components and chemicals at the time of publishing this document. CAS numbers and other limited information are considered proprietary and may not be available for release. **6.** This product is not designed for use in critical life support systems, equipment used in hazardous environments, nuclear control systems or other such applications which necessitate specific safety and regulatory standards other than the ones listed in this datasheet. **7.** Warranty is in accordance with Aimtec's standard Terms of Sale available at www.aimtec.com.