



Crystal Clock Oscillator Specification

IQD Part No. + Packaging: LFSPX0073905RL3K

Würth Part No. 830207390509



Description

- Suitable for real time clock applications
32.768kHz output crystal oscillators
Ceramic package with a seam sealed metal lid, hermetically sealed
- Model CFPS-109
- Model Issue number 5

Frequency Parameters

- Frequency 32.7680kHz
- Frequency Stability ± 30.00 ppm
- Operating Temperature Range -40.00 to 85.00 °C
- Ageing ± 3 ppm max per year

Electrical Parameters

- Supply Voltage $3.3V \pm 5\%$
- Current Draw 3.500mA

Output Details

- Output Compatibility CMOS
- Drive Capability 15pF max
- Rise and Fall Time 50.0ns max
- Duty Cycle 40/60%

Output Control

- Standby Operation:
Logic '1' to pad 1 enables oscillator output
Logic '0' to pad 1 disables oscillator output; when disabled the oscillator output goes to the high impedance state
No connection to pad 1 enables oscillator output
- Start-up Time: 35ms max
2ms typ to 90% of final amplitude (under ideal conditions @ 25°C)
- Standby Current: 10 μ A max, 1.35 μ A typ @ 25°C

Environmental Parameters

- Storage Temperature Range: -55 to 125 °C
- Shock: MIL-STD-883F, Method 2002.4: 1500G, 0.5ms, 3 times in each of 3 mutually perpendicular planes.
- Vibration: MIL-STD-883F, Method 2007.3: 20G (20Hz-2000Hz), 1.52mm amplitude

Manufacturing Details

- RoHS Terminations NiAu
- RoHS Reflow Temp 260degC 10s

Compliance

- RoHS Status (2011/65/EU) Compliant
- REACH Status Compliant
- MSL Rating (JDEC-STD-033): Not Applicable

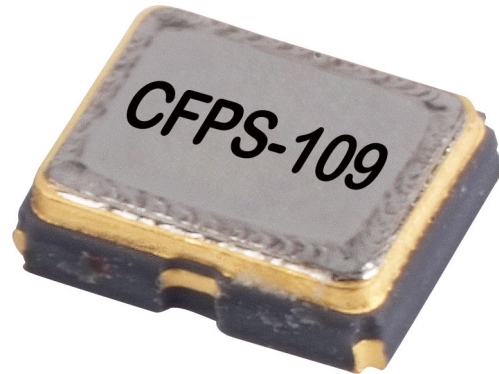

Outline (mm)

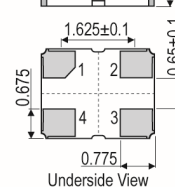
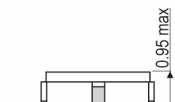
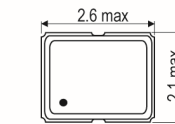

Pad Connections

1. Standby Operation
2. GND
3. Output
4. +Vs

Solder Pad Layout

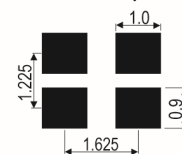

Test Circuit

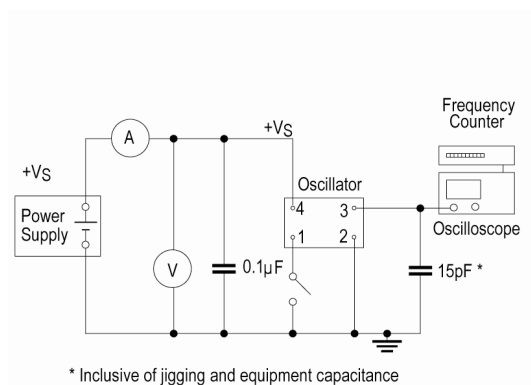

CONTACT INFORMATION:

Würth Elektronik eiSos GmbH & Co. KG
Max-Eyth-Str. 1, 74638 Waldenburg, Germany
Tel: +49(0) 7942 945-0

Email: eiSos@we-online.de
Web: www.we-online.com



Crystal Clock Oscillator Specification

IQD Part No. + Packaging: LFSPXO073905RL3K

Würth Part No. 830207390509



Packaging Details

- Pack Style: RL3K Tape & reel in accordance with EIA-481-D
Pack Size: 3,000
- Alternative packing option available

USEFUL LINKS

Toolbox:

www.we-online.com/toolbox

Product Catalog:

www.we-online.com/products

Wave Form

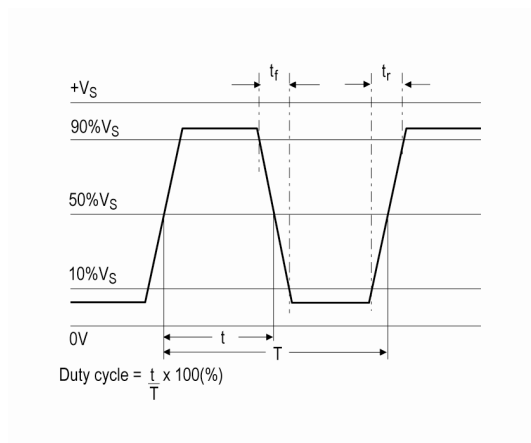

CONTACT INFORMATION:

Würth Elektronik eiSos GmbH & Co. KG
Max-Eyth-Str. 1, 74638 Waldenburg, Germany
Tel: +49(0) 7942 945-0

Email: eiSos@we-online.de
Web: www.we-online.com