



SPECIFICATION SHEET

SPECIFICATION SHEET NO.	Q0618-CP3M580000S030
DATE	June 18, 2023
REVISION	A0
DESCRIPTION	MHz SMD Ceramic Resonator, 6030 Type, L6.0*W3.0*H1.5mm, Built-in Capacitance, 3 pads, CRTP Series 3.5800MHz, Frequency Accuracy $\pm 0.5\%$, Operating Temp. Range $-25^{\circ}\text{C} \sim +85^{\circ}\text{C}$, Reflow Profile Condition 260°C Max. RoHS/RoHS III compliant, Tape/Reel, 4000pcs/Reel
CUSTOMER	
CUSTOMER PART NUMBER	
CROSS REF. PART NUMBER	
ORIGINAL PART NUMBER	TGS CRTP 3.58MG-30 TLF
PART CODE	CP3M580000S030

VENDOR APPROVE			
Issued/Checked/Approved			
DATE: June 18, 2023			

CUSTOMER APPROVE	
DATE:	
6/18/2023	

SMD CERAMIC RESONATOR CRTP SERIES

MAIN FEATURE

- SMD Ceramic Resonator, L6.0*W3.0*H1.5mm, 3 pads
- Low cost & Built-in Capacitance
- Reflow Profile Condition 260 °C Max.
- Wide Frequency Range
- Cross more competitors part
- RoHS III compliant



APPLICATION

- Bluetooth, wireless communication set
- Communication Electronics

PART CODE GUIDE

RFQ
Request For Quotation

CP	3M580000	S	030
1	2	3	4

1) CP: Part Code for SMD Ceramic Resonator, Built-in Capacitance, 3 pads, L6.0*W3.0*H1.5mm, CRTP SERIES

2) 3M580000: Frequency range code for 3.58000MHz

3) S: SMD type, Package Tape/Reel

4) 030: Specification code for original part No.: TGS CRTP 3.58MG-30 TLF

SMD CERAMIC RESONATOR CRTP SERIES

DIMENSION (Unit: mm)

Image for reference



CRTP

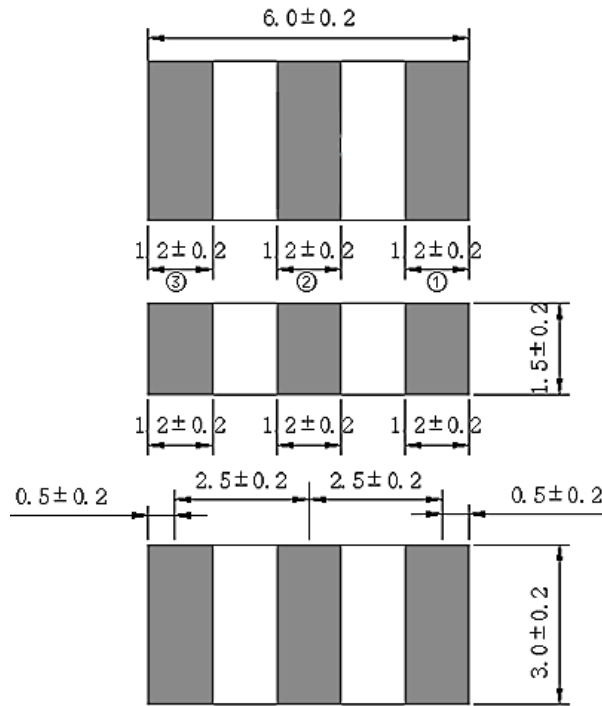

- ① Input
- ② Ground
- ③ Output

Recommend Pad Layout

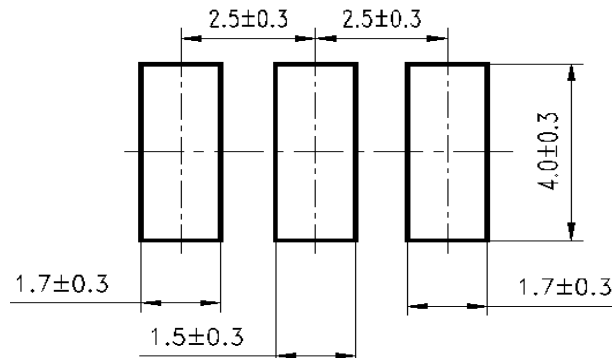

SMD CERAMIC RESONATOR CRTP SERIES
ELECTRICAL PARAMETERS

Parameter	Part No. Symbol	Units	Value			Condition
			Min.	Typical	Max.	
Original Manufacturer	TGS	TGS Crystals				
Holder Type	CRTP	SMD Ceramic Resonator, L6.0*W3.0*H1.5mm, 3 pads				
Frequency Range	3.58	MHz	3.58000			
Withstanding Voltage	MG	V	100			@DC, 1 min
Insulation Resistance		MΩ	500			@AV, 1 min.
Operation Temperature		°C	-25		+85	
Storage Temperature		°C	-55		+85	
Rating Voltage		V	6			DC
			15			p-p
Frequency Accuracy		%	±0.5			
Resonant Impedance		Ω		40	60	
Temperature Coefficient of Oscillation Frequency		%			±0.3	Oscillation Frequency drift, -25°C ~ +85°C)
Oscillation Frequency Aging Rate (10 years)		%			±0.3	From initial value
IC application		1/6TC4069UBP×2				
Design Mode						
Built-in Capacitance	-30	pF	30pF (±20%)			
Other	Package	T	Tape/Reel			
	RoHS Status	LF	RoHS III compliant			
	Add Value		N/A			
	Internal Control Code		2 letter or digits; Blank: N/A			

Note: Original Part Number: TGS CRTP 3.58MG-30 TLF

SMD CERAMIC RESONATOR CRTP SERIES
RELIABILITY

Test Items	Test Method And Conditions	Performance Requirements
Humidity	Keep the resonator at 60°C±2°C and 90%-95% RH for 96h. Then Release the resonator into the room Condition for 1h prior to the Measurement.	It shall fulfill the specifications in Table 1.
High Temperature Exposure	Subject the resonator to 85°C±2°C for 96h, then release the resonator into the room conditions for 1h prior to the measurement.	It shall fulfill the specifications in Table 1.
Low Temperature Exposure	Subject the resonator to -40°C±2°C for 96h, then release the resonator into the room conditions for 1h prior to the measurement.	It shall fulfill the specifications in Table 1.
Temperature Cycling	Subject the resonator to -25°C±3°C for 30±3 min. followed by a high temperature of 85°C ±3°C for 30±3 min. Cycling shall be repeated 5 times with a transfer time of 15s. At the room temperature for 1h prior to the measurement.	It shall fulfill the specifications in Table 1.
Vibration	Subject the resonator to vibration for 2h each in x, y and z axis With the amplitude of 1.5mm, the frequency shall be varied uniformly between the limits of 10 Hz—55Hz.	It shall fulfill the specifications in Table 1.
Mechanical Shock	Drop the resonator randomly onto a wooden floor from the height of 100cm 3 times.	It shall fulfill the specifications in Table 1.
Soldering Test	Passed through the re-flow oven under the following condition and left at room temperature for 1h before measurement	It shall fulfill the specifications in Table 1.
Solder Ability	Dipped in 245°C±5°C solder bath for 3s±0.5 s with rosin flux (25wt% ethanol solution.)	The terminals shall be at least 95% covered by solder.
Board Bending	Mount a glass-epoxy board (Width=40mm,thickness=1.6mm),then bend it to 1mm displacement and keep it for 5s. (See the following figure 1)	Mechanical damage such as breaks shall not occur.

SMD CERAMIC RESONATOR CRTP SERIES

Table 1

Item	Specification after test
Oscillation Frequency Change $\Delta F_{osc}/F_{osc}$ (%) max	± 0.3
Resonant Impedance (Ω) max	60
The limits in the above table are referenced to the initial measurements.	

SUGGESTED REFLOW PROFILE (For Reference Only)

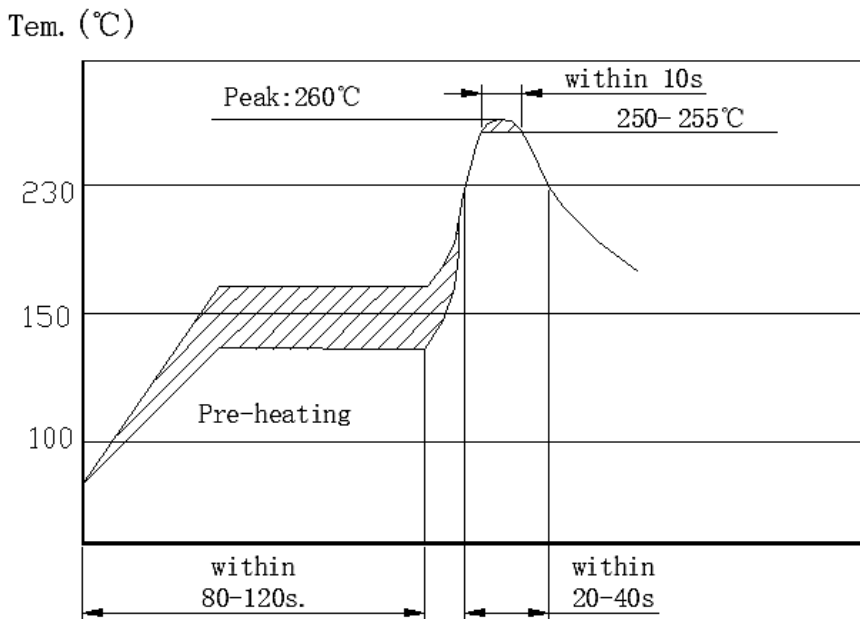

BOARD BENDING TEST- FIGURE 1

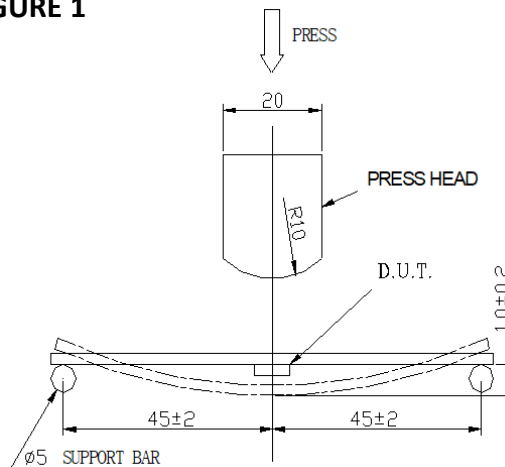

SMD CERAMIC RESONATOR CRTP SERIES

TEST CIRCUIT (For Reference Only)

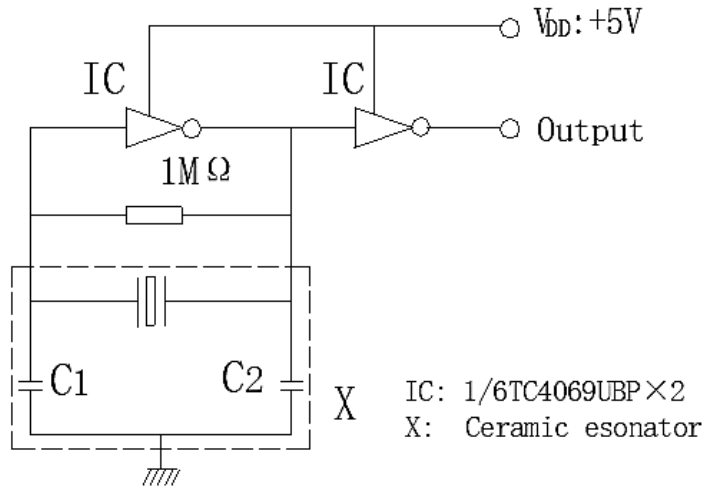

Note:

Parts shall be tested under the condition (Temp.: 20±15°C, Humidity 65±20% R.H.) unless the standard condition(Temp.: 25±3 °C, Humidity :65±10% R.H.) is regulated to measure.

SMD CERAMIC RESONATOR CRTP SERIES

TAPE/REEL (Unit: mm)

All Devices are packed in accordance with EIA standard RS-481-2 and specifications, 4000pcs/Reel, Carrier tape size-16,

Reel

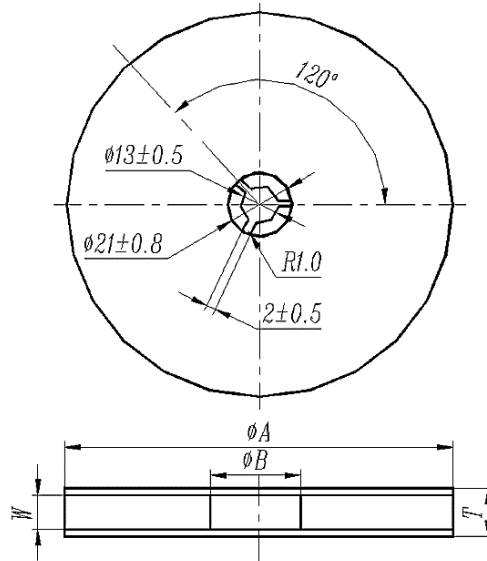

Symbol	Dimension
ϕA	330 ± 3.0
ϕB	80.0 Min.
W	16.4 Min.
T	22.4 Max.

Packing Method Sketch Map

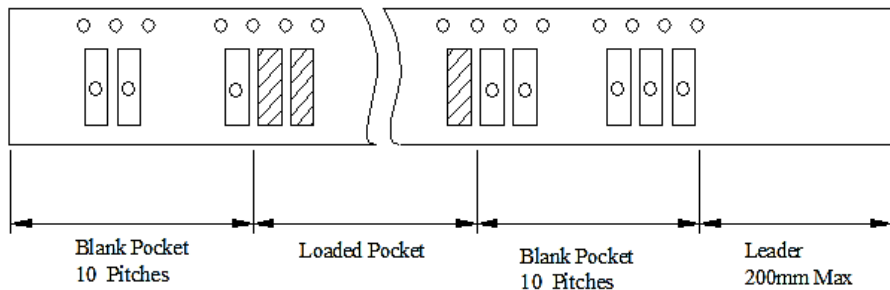

Test Condition Of Peeling Strength

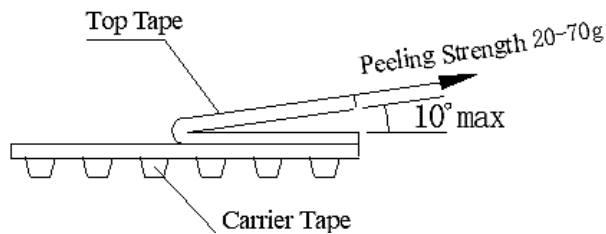

SMD CERAMIC RESONATOR CRTP SERIES

NOTES

- Don't apply excess mechanical stress to the component and terminals at soldering. Do not use this product with bend.
- Do not clean or wash the component for it is not hermetically sealed.
- Do not use strong acidity flux, more than 0.2wt% chlorine content, in flow soldering.
- Don't be close to fire.
- This specification mentions the quality of the component as a single unit. Please insure the component is thoroughly evaluated in your application circuit
- Expire date (Shelf life) of the products is 12 months after delivery under the conditions of a sealed and an unopened package. Please use the products within 12 months after delivery. If you store the products for a long time (more than 12 months), use carefully because the products may be degraded in the solder-ability or rusty. Please confirm solder-ability and characteristics for the products regularly.
- Exposure components under soldering condition that is exceeding our recommendation will increase the failure dangerous.
- Please contact us before using the product as automobile electronic component.
- Please return one of these specifications after your signature of acceptance.
- When something gets doubtful with this specifications, we shall jointly work to get an agreement.
- For questions on technology, prices and delivery, please contact our sales offices or e-mail:
sales@NextGenComponent.com .

DISCLAIMER

NextGen Components, Inc. reserves the right to make changes to the product(s) and or information contained herein without notice. No liability is assumed as a result of their use or application. No rights under any patent accompany the sale of any such product(s) or information

6/18/2023