

WIDEBAND RF PULSE COUPLING TRANSFORMERS

- * Designed for use in 50 W WideBand R.F. and Fast Rise Time Applications
- * Impedance Levels from 12.5 to 800 Ohms
- * Low Insertion Loss, 500Vrms Isolation
- * Frequency Range 10 KHz to 500 MHz
- * 6-Pin DIP & Gull Wing Packages

ELECTRICAL SPECIFICATIONS AT 25°C - OPERATING TEMPERATURE RANGE -40°C TO +85°C

PART NUMBER	TURNS RATIO (± 5%)	PRIMARY Inductance (μH Min.)	ET V-μsec (Min.)	Rise Time ns Max	PRI-SEC Cw/w (pf Max.)	PRI / SEC L _L (μH Max.)	PRI DCR (Ω Max.)	SEC DCR (Ω Max.)	-3dB Bandwidth MHz		Sch-matic
									Low	High	
PM-WT01	1:1	80	2.50	2.20	12	0.15	0.20	0.20	0.05	110	B
PM-WT02	1:2	40	2.00	3.00	15	0.14	0.20	0.30	0.10	110	B
PM-WT03	1:4	20	1.25	6.00	10	0.10	0.20	0.60	0.20	60	B
PM-WT04	1:1ct	80	2.50	3.00	15	0.18	0.20	0.20	0.05	90	E
PM-WT05	1:2ct	40	2.00	3.00	15	0.14	0.20	0.30	0.10	110	E
PM-WT06	1:4ct	20	1.25	6.00	10	0.10	0.20	0.60	0.20	60	E
PM-WT07	1ct:1ct	80	2.50	3.00	15	0.18	0.20	0.20	0.05	90	C
PM-WT08	1ct:2ct	40	2.00	3.00	15	0.14	0.20	0.30	0.10	110	C
PM-WT09	1:1:1	40	2.00	2.00	12	0.10	0.20	0.20	0.10	150	A
PM-WT10	1ct:1ct	800	4.00	6.00	30	0.30	0.26	0.26	0.005	100	C

THRU HOLE OR SURFACE MOUNT:

Table Part Numbers are THRU HOLE
Change the "T" to "G" for SURFACE MOUNT.

Example:

PM-WT01 = THROUGH-HOLE

PM-WG01 = SURFACE MOUNT

VARIATIONS AVAILABLE. FOR INTERMEDIATE VALUES AND/OR CUSTOM DESIGNS PLEASE CONSULT THE FACTORY.

MECHANICAL

PHYSICAL DIMENSIONS DIMENSIONS IN INCHES (mm)

THRU-HOLE PACKAGE

PM-WTXX

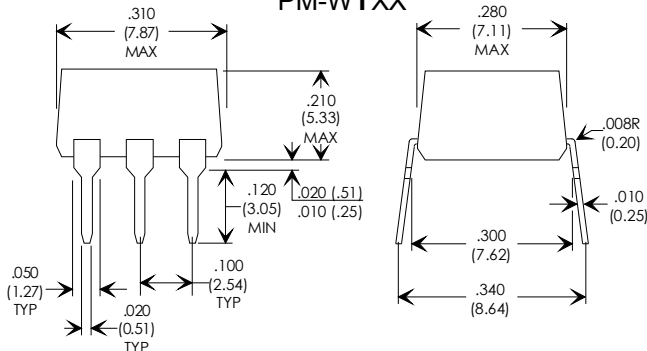

SURFACE MOUNT PACKAGE

PM-WGXX

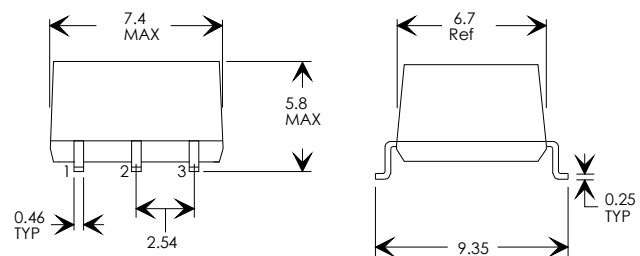

SCHEMATICS

SCHEMATIC "A"

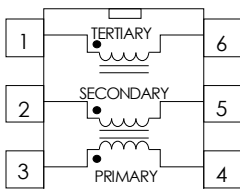

SCHEMATIC "B"

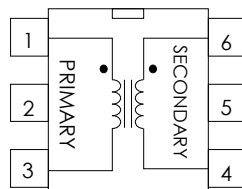

SCHEMATIC "C"

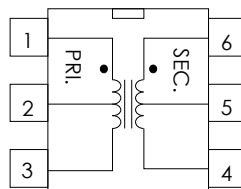

SCHEMATIC "D"

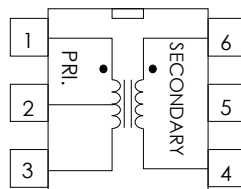

SCHEMATIC "E"

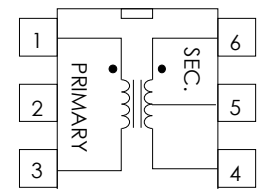

Specifications subject to change without notice.

pm-wt 09/2015

FDDI & GIGABIT COPPER MEDIA COUPLING TRANSFORMERS

- * Optimized for Copper Media Applications of Fast Ethernet & FDDI
- * For use in 150 W or 75 W systems to ANSI X3T9.5.
- * Frequency Range 2 MHz to 450 MHz.
- * 2000Vrms Isolation (Hi-Pot).

ELECTRICAL SPECIFICATIONS AT 25°C - OPERATING TEMPERATURE RANGE -40°C TO +85°C

PART NUMBER	CABLE MEDIA TYPE	Baud Rate (MHz)	PRIMARY* Inductance (μH Typ.)	TURNS RATIO (± 5%)	PRI-SEC Cw/w (pf Max.)	PRI / SEC L _L (μH Max.)	PRI/SEC DCR (Ω Max.)	Rise Time (ns Max.)	-3dB Bandwidth MHz	
									Low Max.	High Typ.
PM-WT75	75W/150W	266+	7.0	1:1	2.5	0.08	0.15	0.50	2.5	410
PM-WT76	75W/150W	266+	7.0	1ct:1ct	2.5	0.08	0.15	0.50	2.5	350
PM-WT150	150W STP	266	15.0	1:1	2.5	0.08	0.15	0.80	2.0	410
PM-WT20	75W Coax	133	30.0	1:1	4.0	0.10	0.20	1.50	0.5	250
PM-WT30	150W STP	133	60.0	1:1	5.5	0.10	0.20	2.00	0.5	200

APPLICATION NOTE:

The PM-WT75 & PM-WT150 versions have been optimized for use with 8B/10B code and NRZ modulation as used in HOTLink™ for communication. One of the main advantages of 8B/10B code is the elimination of baseline wander concerns (DC bias). Methods of encoding that are not DC balanced, such as FDDI 4B/5B require a compromise in the magnetics design as more turns (higher inductances) are necessary to combat the DC imbalance. Thus the major design consideration for 8B/10B code was to provide sufficient high end bandwidth to allow passage of at least the 3rd harmonic. In a system operating at a 266 MHz baud rate this 3rd harmonic is at 399MHz. The PM-WT75 should be used for both 75W & 150W applications using 8B/10B coding @ ≥ 266MHz Baud Rates.

HOTLink™ is a Trade Mark of CYPRESS SEMICONDUCTOR Inc.
CY7B923 HOTLink™ Transmitter & CY7B933 HOTLink™ Receiver.

MECHANICAL

PHYSICAL DIMENSIONS IN INCHES (mm)

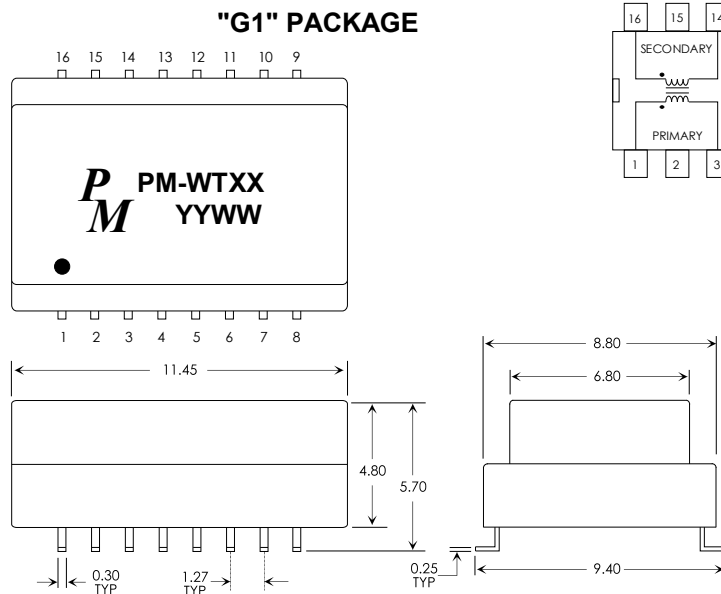

Specifications subject to change without notice.

SCHEMATIC

PM-WT75,150,20,30

PM-WT76

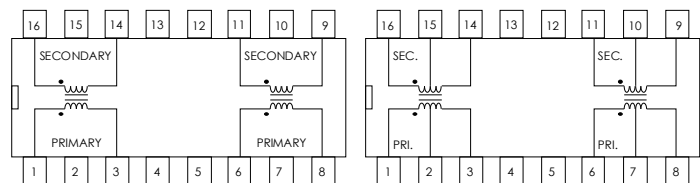
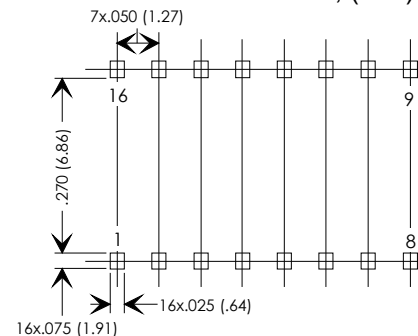

FIGURE 3: RECOMMENDED PCB LAYOUT
DIMENSION IN INCHES, (mm)



pm-wt 09/2015

3KV REINFORCED INSULATION COUPLING TRANSFORMER

- * Optimized for use with CYPRESS Semiconductor HOTLink™ Chip Set
- * For use in 150 W STP or 75 W Coax, Copper Media Applications of Fast Ethernet, FDDI & ATM
- * IEC950, UL1950, CSA-950, 3000Vrms Reinforced Insulation System. $\geq 6.2\text{mm}$ Creepage/Clearance

HOTLink™ is a Trade Mark of CYPRESS SEMICONDUCTOR Inc.
CY7B923 HOTLink™ Transmitter & CY7B933 HOTLink™ Receiver.

ELECTRICAL SPECIFICATIONS AT 25°C - OPERATING TEMPERATURE RANGE -40°C TO +85°C

PART NUMBER	CABLE MEDIA TYPE	Baud Rate (MHz)	PRIMARY* Inductance (μH Typ.)	TURNS RATIO ($\pm 5\%$)	PRI-SEC Cw/w (pf Max.)	PRI / SEC L_L (μH Max.)	PRI/SEC DCR (Ω Max.)	Rise Time (ns Max.)	-3dB Bandwidth MHz	
									Low Max.	High Min.
TSD-1227*	50/75W	266+	7.0	1:1	1.5	0.13	0.15	0.50	2.0	380

*APPLICATION NOTE: Reinforced Insulation System per IEC950, UL1950, CSA-950.

The TSD-1227, 3KV reinforced insulation version of the PM-WT75 was optimized for use with 8B/10B code and NRZ modulation as used in HOTLink™ for communication. One of the main advantages of 8B/10B code is the elimination of baseline wander concerns (DC bias). Methods of encoding that are not DC balanced, such as FDDI 4B/5B require a compromise in the magnetics design as more turns (higher inductances) are necessary to combat the DC imbalance. Thus the major design consideration for 8B/10B code was to provide sufficient high end bandwidth to allow passage of at least the 3rd harmonic. In a system operating at a 266 MHz baud rate this 3rd harmonic is at 399MHz. The TSD-1227 should be used for both 75W & 150W applications using 8B/10B coding @ $\geq 266\text{MHz}$ Baud Rates.

MECHANICAL

PHYSICAL DIMENSIONS IN INCHES (mm)

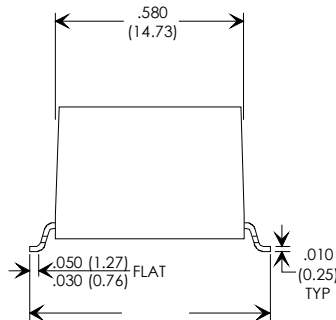
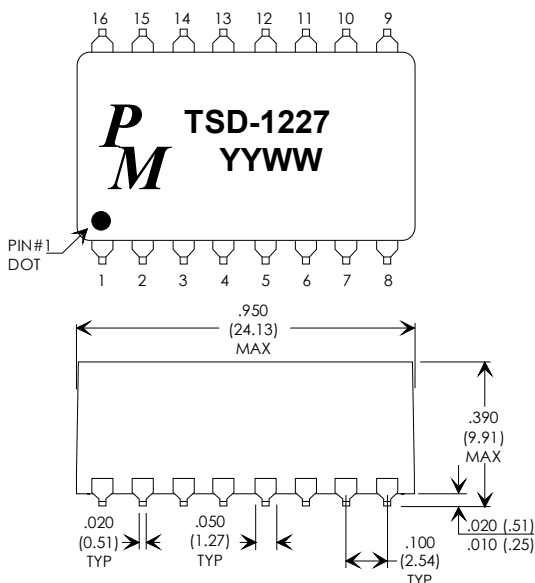

SCHEMATIC

RECOMMENDED PCB LAYOUT DIMENSION IN INCHES, (mm)

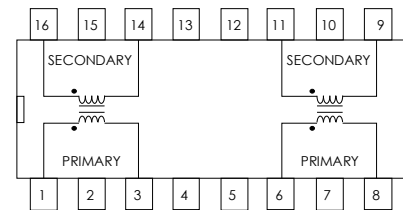
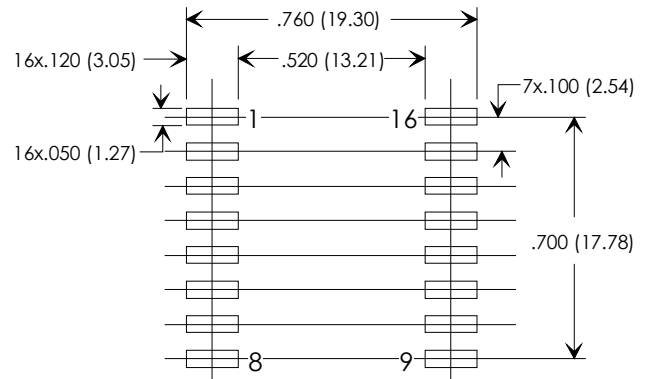

Specifications subject to change without notice.

pm-wt 09/2015