



SPECIFICATION SHEET

SPECIFICATION SHEET NO.	R0120- CA45LB010K476T	
DATE	Jan. 20, 2024	
REVISION	A0	Updated With Most Recent Data - Official First Release
DESCRIPTION AND MAIN PARAMETRICS	<p>SMD Tantalum Capacitors Industrial Grade, Low ESR, MnO₂, CA45L Series EIA code 3528-19 (1210), Case B, L3.5*W2.8*H1.9mm Rated Voltage 10 Vdc, Capacitance 47μF, Tolerance ±10%, ESR 0.65 Ω Max. Operating Temp. Range -55° C ~+125° C, Package in Tape/Reel, 2000pcs/Reel REACH/RoHS/RoHS III compliant</p>	
CUSTOMER		
CUSTOMER PART NO.		
CROSS REF. PART NO.	T494/T495/T510/TSM/TPS/F91/TPM/593D	
ORIGINAL MFG/PART NO.	XiangYi/ CA45L-B010K476TE650	
PART CODE	CA45LB010K476T	

VENDOR APPROVE			
Issued/Checked/Approved			
DATE: Jan. 20, 2024			

CUSTOMER APPROVE	
DATE:	

SMD TANTALUM CAPACITORS CA45L SERIES CASE B

MAIN FEATURE

- Epoxy Molded Encapsulation, Chip, Small In Size, Light In Weight
- Easy For Integration, Heteroploidy
- Lower ESR Than The Standard Chip Tantalum Capacitor
- Stable In Electrical & Storage Performances, Long Life-span
- Executive Technical Standards: QJ/PWV305-2008
- REACH/RoHS/RoHS III compliant
- Wide Operating Temperature Range -55 ~ +125°C
- Cross Most Competitors Parts in Market



APPLICATION

- DC/DC Converters,
- Portable Electronics ,
- Telecommunications And Control Units;

ELECTRICAL CHARACTERISTICS

- See Page 9~ Page 11 For Different Part Code

HOW TO ORDER

- Please follow up Part Code Guide and indicate pat code when you order or RFQ.

SMD TANTALUM CAPACITORS CA45L SERIES CASE B

PART CODE GUIDE

RFQ

[Request For Quotation](#)

CODE	NAME	KEY SPECIFICATION OPTION
CA45L	Product Series Code	SMD Low ESR Chip Tantalum Capacitors Industrial Grade MnO ₂
B	Case Size Code For Dimension	A: 3216-16 (1206), L3.2*W1.6*H1.6mm; B: 3528-19 (1210), L3.5*W2.8*H1.9mm C: 6032-25 (2312), L6.0*W3.2*H2.50mm; D: 7343-28 (2917), L7.3*W4.3*H2.8mm E: 7343-41 (2917), L7.3*W4.3*H4.1mm; F: 7361-19 (2924), L7.3*W6.1*H1.9mm H: 7343-21 (2917), L7.3*W4.3*H2.1mm; V: 7361-36 (2924), L7.3*W6.1*H3.6mm
010	Rated voltage Code	004: 4V; 6R3: 6.3V; 010: 10V; 016: 16V; 020: 20V; 025: 25V; 035: 35V; 050: 50V
K	Capacitance Tolerance code	K: ±10%; M: ±20%
476	Capacitance Code	1st two digits represent Significant figures, 3rd Digit specifies number of Zeros 474: 0.47µF; 684:0.68µF; 105: 1.0µF; 155: 1.5µF; 225: 2.2µF; 335: 3.3µF; 475: 4.7µF; 685: 6.8µF; 106: 10µF; 156: 15µF; 226: 22µF; 336: 33µF; 476: 47µF; 686: 68µF; 107: 100µF; 157: 150µF; 227: 220µF; 337: 330µF; 477: 470µF; 108: 1000µF; 158: 1500µF; 228: 2200µF
T	Internal Control Code	Letter A~Z Or Digits (1-9)
()	Custom Specification Code	Letter A~Z Or Digits (1-9); Blank: N/A

SMD TANTALUM CAPACITORS CA45L SERIES CASE B

DIMENSION (Unit: mm)

Image for reference

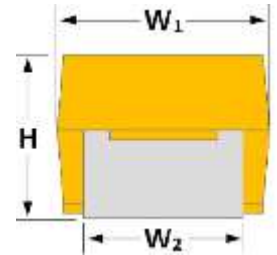
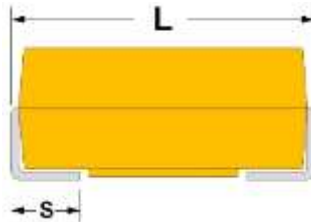
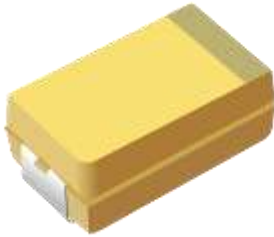

Case Size Code	EIA Code	EIA Metric	L	W ₁	H	S	W ₂
A	1206	3216-16	3.20±0.20	1.60±0.20	1.60±0.30	0.70±0.20	1.20±0.20
B	1210	3528-19	3.50±0.20	2.80±0.20	1.90±0.30	0.70±0.20	2.20±0.20
C	2312	6032-25	6.00±0.30	3.20±0.30	2.50±0.30	1.30±0.30	2.20±0.20
D	2917	7343-28	7.30±0.30	4.30±0.30	2.80±0.30	1.30±0.30	2.40±0.20
E	2917	7343-41	7.30±0.30	4.30±0.30	4.10±0.30	1.30±0.30	2.40±0.20
F	2924	7361-19	7.30±0.30	6.10±0.30	1.90±0.30	1.40±0.30	3.00±0.20
H	2917	7343-21	7.30±0.30	4.30±0.30	2.10±0.30	1.30±0.30	2.40±0.20
V	2924	7361-36	7.30±0.30	6.10±0.30	3.60±0.30	1.40±0.30	3.00±0.20

SMD TANTALUM CAPACITORS CA45L SERIES CASE B
LAND DIMENSIONS

Density Level A: For low-density product applications. Recommended for wave solder applications and provides a wider process window for reflow solder processes.

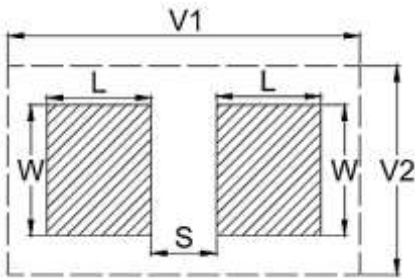

Note:

- Height of these chips may create problems in wave soldering.
- Land pattern geometry is too small for silkscreen outline.

Case Code	EIA Metric	Dimension (mm)				
		W	L	S	V1	V2
A	3216-16	1.35	2.20	0.62	6.02	2.80
B	3528-19	2.35	2.21	0.92	6.32	4.00
C	6032-25	2.35	2.77	2.37	8.92	4.50
D	7343-28	2.55	2.77	3.67	10.22	5.60
E	7343-41	2.55	2.77	3.67	10.22	5.60
F	7361-19	3.25	2.77	3.67	10.22	7.30
H	7343-21	2.55	2.77	3.67	10.22	5.60
H1	7343-15	2.55	2.77	3.67	10.22	5.60
L	7343-19	2.55	2.77	3.67	10.22	5.60
V	7361-36	3.25	2.77	3.67	10.22	7.30
W	7361-41	3.25	2.77	3.67	10.22	7.30
Y	7343-40	2.55	2.77	3.67	10.22	5.60

SMD TANTALUM CAPACITORS CA45L SERIES CASE B

LAND DIMENSIONS

Density Level B: For products with a moderate level of component density. Provides Recommended Profile

Conditions for reflow solder processes.

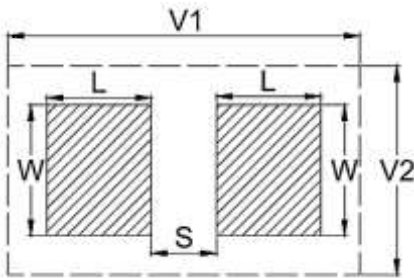

Note:

- Height of these chips may create problems in wave soldering.
- Land pattern geometry is too small for silkscreen outline.

Case Code	EIA Metric	Dimension (mm)				
		W	L	S	V1	V2
A	3216-16	1.23	1.80	0.82	4.92	2.30
B	3528-19	2.23	1.80	1.12	5.22	3.50
C	6032-25	2.23	2.37	2.57	7.82	4.00
D	7343-28	2.43	2.37	3.87	9.12	5.10
E	7343-41	2.43	2.37	3.87	9.12	5.10
F	7361-19	3.13	2.37	3.87	9.12	6.80
H	7343-21	2.43	2.37	3.87	9.12	5.10
H1	7343-15	2.43	2.37	3.87	9.12	5.10
L	7343-19	2.43	2.37	3.87	9.12	5.10
V	7361-36	3.13	2.37	3.87	9.12	6.80
W	7361-41	3.13	2.37	3.87	9.12	6.80
Y	7343-40	2.43	2.37	3.87	9.12	5.10

SMD TANTALUM CAPACITORS CA45L SERIES CASE B

LAND DIMENSIONS

Density Level C: For high component density product applications. Before adapting the Min. land pattern variations, the user should perform qualification testing based on the conditions outlined in IPC - 7351).

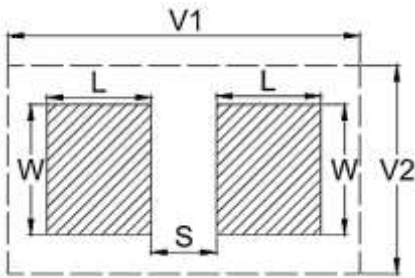

Note:

- Height of these chips may create problems in wave soldering.
- Land pattern geometry is too small for silkscreen outline.

Case Code	EIA Metric	Dimension (mm)				
		W	L	S	V1	V2
A	3216-16	1.13	1.42	0.98	4.06	2.04
B	3528-19	2.13	1.42	1.28	4.36	3.24
C	6032-25	2.13	1.99	2.73	6.96	3.74
D	7343-28	2.33	1.99	4.03	8.26	4.84
E	7343-41	2.33	1.99	4.03	8.26	4.84
F	7361-19	3.03	1.99	4.03	8.26	6.54
H	7343-21	2.33	1.99	4.03	8.26	4.84
H1	7343-15	2.33	1.99	4.03	8.26	4.84
L	7343-19	2.33	1.99	4.03	8.26	4.84
V	7361-36	3.03	1.99	4.03	8.26	6.54
W	7361-41	3.03	1.99	4.03	8.26	6.54
Y	7343-40	2.33	1.99	4.03	8.26	4.84

SMD TANTALUM CAPACITORS CA45L SERIES CASE B

MARKING

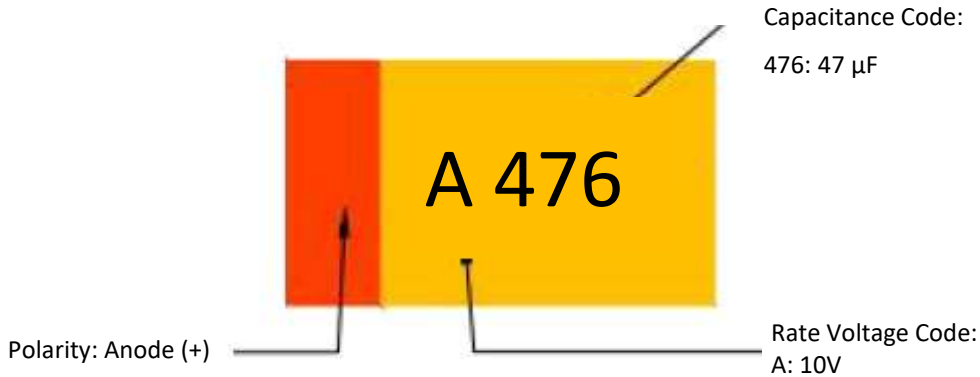

Voltage Code	F	G	J	A	C	D	E	V	T
Rate Voltage (V)	2.5	4.0	6.3	10	16	20	25	35	50

MAXIMUM OPERATING AND SURGE VOLTAGES VS. TEMPERATURE

Rate Voltage (V _R)	≤ 85°C	2.5	4.0	6.3	10	16	20	25	35	50
Category Voltage (V _C)	≤ 125°C	1.7	2.7	4	6.3	10	15	17	23	33
Surge Voltage (V _S)	≤ 85°C	3.3	5.2	8	13	20	26	32	46	65
Surge Voltage (V _S)	≤ 125°C	2.2	3.4	5	8	13	16	20	28	40

SMD TANTALUM CAPACITORS CA45L SERIES CASE B

BASIC INFORMATION

ITEM	CHARACTERISTIC
Dielectric	Ta2O5
Electrolyte	MnO2
Package Method	Epoxy Resin Molding (Semi-Seal)
Case Color	Yellow (std.) or Black
MSL	1
Termination Finish	Standard solder-coated, Gold-plated option

STANDARD CHARACTERISTICS

PART CODE	CA45LB010K476T
Case Size Code	B
Case Dimension	L3.5*W2.8*H1.9mm
EIA Code	1210 (3528-19)
Capacitance Tolerance	±10%
Rate Temperature Range	85 °C
Category Voltage	6.7 V
Category Temperature Range	125 °C
Operating Temperature Range	-55~ + 125 °C

SMD TANTALUM CAPACITORS CA45L SERIES CASE B
ELECTRONICAL CHARACTERISTICS FOR MAIN PARTS

Part Code	Rate Voltage ≤ 85°C	Cap. @25°C 100Hz	ESR @25°C 100 KHz	Max. Dissipation Factor (DF) @25°C 100Hz	Max. Leakage Current @+25°C 5 min.	Max. Ripple Current		
						@ 25°C 100 KHz	@ 85 °C 100 KHz	@ 125°C 100 KHz
						V	μF	Ω
CA45LA6R3K107T	6.3	100±10%	1.5	26	6.3	224	201	89
CA45LB6R3K107T	6.3	100±10%	0.5	14	6.3	412	371	165
CA45LB6R3M227T	6.3	220±20%	0.6	18	14	376	339	151
CA45LD6R3K477T	6.3	470±10%	0.2	14	30	866	779	346
CA45LA010K106T	10	10±10%	1.8	6	1.0	204	184	82
CA45LB010K476T	10	47±10%	0.65	8	4.7	362	325	145
CA45LC010K107T	10	100±10%	0.25	8	10	663	597	265
CA45LC010K227T	10	220±10%	0.15	16	22	856	771	343
CA45LD010K227T	10	220±10%	0.15	8	22	1000	900	400
CA45LD010K107T	10	100±10%	0.20	8	10	866	779	346
CA45LE010M477T	10	470±20%	0.15	14	47	1049	944	420
CA45LC016K107T	16	100±10%	0.2	12	16	742	667	297
CA45LC016K476T	16	47±10%	0.35	6	7.5	561	505	224
CA45LD016K107T	16	100±10%	0.15	8	16	1000	900	400
CA45LD016K476T	16	47±10%	0.30	6	7.5	707	636	283
CA45LE016M227T	16	220±20%	0.20	10	35	908	817	363
CA45LC020K686T	20	68±10%	0.40	8	14	524	472	210
CA45LD035K226T	35	22±10%	0.40	6	7.7	612	551	245
CA45LE035M476T	35	47±20%	0.40	10	16	642	578	257
CA45LD050K685T	50	6.8±10%	0.6	6	3.4	500	450	200

SMD TANTALUM CAPACITORS CA45L SERIES CASE B

ELECTRONICAL CHARACTERISTICS

Part Code	Rate Voltage ≤ 85°C	Cap. @25°C 100Hz	ESR @25°C 100 KHz	Max. Dissipation Factor (DF) @25°C 100Hz	Max. Leakage Current @+25°C 5 min.	Max. Ripple Current		
						@ 25°C 100 KHz	@ 85 °C 100 KHz	@ 125°C 100 KHz
						V	μF	Ω
CA45LE050K475T	50	4.7±10%	0.3	6	2.4	742	667	297

SMD TANTALUM CAPACITORS CA45L SERIES CASE B

APPLICATION NTOE

Storage Condition

- 1) Environmental temperature: 10°C ~ +30°C
- 2) Relative humidity no more than 60%
- 3) Storing period: No more than one and half year since the date of stocking.

APPLICATION GUIDE

1) Ripple Current and Voltage

If the ripple current is applied to the capacitor, the Joule heat (power dissipated) will be generated in the capacitor, so it will affect the reliability of the capacitor.

(1) Power Dissipated

The actual power dissipated can be calculated using the following formula: $P=I^2 \times ESR$Formula 1

P: Power dissipated (W); I: Ripple current (A); ESR: Equivalent series resistance (Ω)

Power Dissipation for Case E (EIA Code 7343-43): 125mW Max. @+25°C

(2) Ripple Current

Using the maximum power dissipation 125mW Max., the ripple current can be calculated using the following

formula: $I= \sqrt{\frac{P}{ESR}} \times K \times F$Formula 2

K: Temperature derating factor..... Table 1; F: Frequency derating factor..... Table 2

ESR: Refer to the ratings of each specific product

Table 1: Temperature Drop Factor K

Temperature	Temperature Derating Factor K
25 °C	1
85 °C	0.9
125 °C	0.4

Table 2: Frequency Derating Factor F

Frequency (KHz)	10	100	500	1000
MnO2	0.80	1.0	1.15	1.20
Polymer	0.75	1.0	1.10	1.30

Using formula 3 to calculate corrugated voltage E: $E=Z \times I$ Formula 3

E: Ripple voltage; Z: Specific frequency impedance

SMD TANTALUM CAPACITORS CA45L SERIES CASE B

(3) Ripple Voltage

The ripple voltage applied to the capacitor is limited by three criteria.

- (a) The power dissipation in the ESR of capacitor must not exceed 125mW Max. @+25°C
- (b) The positive peak AC voltage plus the DC bias voltage must not exceed the DC voltage rating of the capacitor.
- (c) The negative peak AC voltage, in combination with the bias voltage, if any , must not exceed the permissible reverse voltage ratings presented .

2) Reverse Voltage

Solid tantalum capacitors are polarized devices , and applied reverse voltage can not be allowed . If the reverse voltage is unavoidable, a small degree of transient reverse voltage is permissible for short periods as follow.

25°C..... 10% of Max. rated voltage or 1V whichever is smaller

85°C..... 5% of Max. rated voltage or 0.5V whichever is smaller

125°C.....1% of Max. rated voltage or 0.1V whichever is smaller

Even under these restrictions, capacitors can not be used continuously in reverse voltage mode.

3) Working Voltage

- (1) For general applications, using 50% of rated voltage of capacitors or less.
- (2) When used at the power circuit, low impedance circuit , coupling circuit or witching circuit which has leakage current problems, please design the circuit with voltage under 30% of the working voltage (max 50%) to avoid the adverse effect of the surge current.
- (3) Derating voltage when temperature above 85°C.

When the chip tantalum capacitor is used at 85°C or more temperatures, the reduced voltage (U_T) is calculated from the following expression, however, note that the ambient temperature is not more than 125°C.

$$U_T = V_0 (U_R - U_C)(T - 85) / 40$$

U_R : Rated voltage (V); U_C : Derating voltage at 125°C; T: Ambient temperature (°C)

SMD TANTALUM CAPACITORS CA45L SERIES CASE B**4) Protective Resistance**

In a circuit (switching circuit, charge / discharge circuit, etc.) that has an instantaneous current, series resistance is at least $3\Omega/V$, this can improve the reliability of tantalum capacitors. If the capacitor is in a low impedance circuit, the voltage applied to the capacitor should be half or one third of the rated voltage.

5) Redundancy

MnO₂ tantalum capacitors will heat, and may cause fire and burn in the short circuit. This is determined by the situation, time and other factors. When the circuit is designed, it is possible to provide the best possible space to keep the tantalum capacitor reliability.

6) Test Condition

Ambient Temperature 25°C; Relative Humidity 60 to 70%; Air Pressure 800 to 1060mbar. Test and experiment, in order to make the test results not problems, it is necessary to will test the product after fully discharge.

This product is a polar components, testing or when using it is strictly prohibited to will is negative pick back, in order to avoid performance failure

7) Soldering

The SMD tantalum capacitor can be used for reflow soldering, which is not suitable for wave soldering and manual welding. The reflow temperature are $\leq 250^{\circ}\text{C}$, ≤ 5 seconds. If you must use manual welding, should use the melted solder to contact lead, and the electric soldering iron power should be less than or equal to 25W, temperature should be less than 300°C , welding time should be less than 3 seconds, can not use electric iron contact the product lead directly, and in particular, can not contact the product ontology directly. Recommended profile conditions for convection and IR reflow reflect the profile conditions of the IPC/J-STD-020D standard for moisture sensitivity testing

SMD TANTALUM CAPACITORS CA45L SERIES CASE B

8) Recommended Profile Conditions

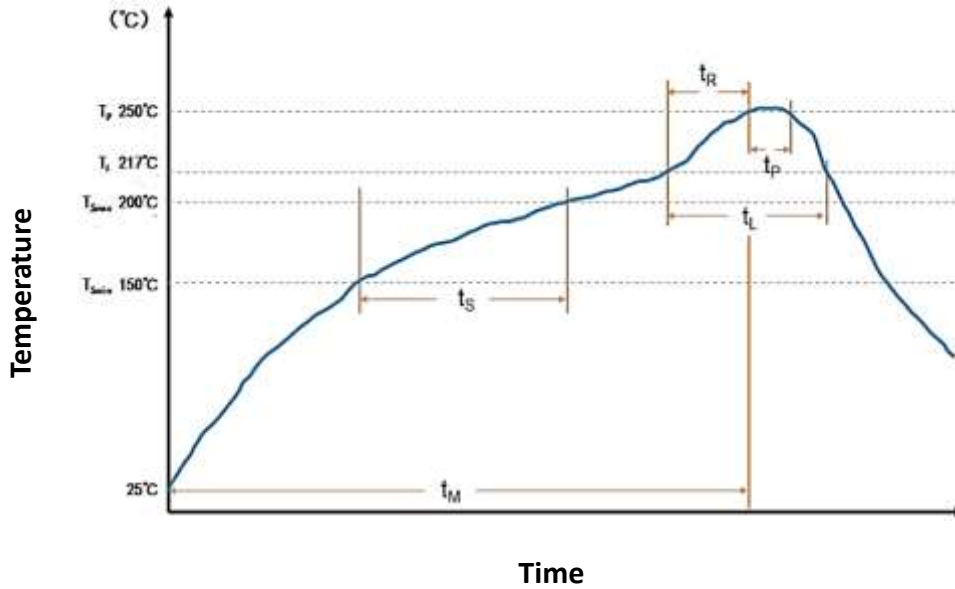

Characteristics	Unit	Symbol	SnPb Assembly	Pb-Free Assemble
Preheat Temperature Min.	°C	T smin	100	150
Preheat Temperature Max.	°C	T smax	150	200
Preheat time	Second	T s	60~120	60~120
Ramp-up Rate	°C/Second	T L to T p	≤ 3	≤ 3
Liquidous Temperature	°C	T L	183	217
Time Above Liquidous	Second	t L	30~150	60~150
Peak Temperature	°C	T p	220 or 235	245 or 250
Time within 5°C Max. Peak Temperature	Second	t p	≤ 10	≤ 3
Ramp-down Rate	°C/Second	T p to T L	≤ 6	≤ 6
Time 25°C to Peak Temperature	minute		≤ 6	≤ 6

SMD TANTALUM CAPACITORS CA45 SERIES E

9) Recommended Voltage Derating Guidelines

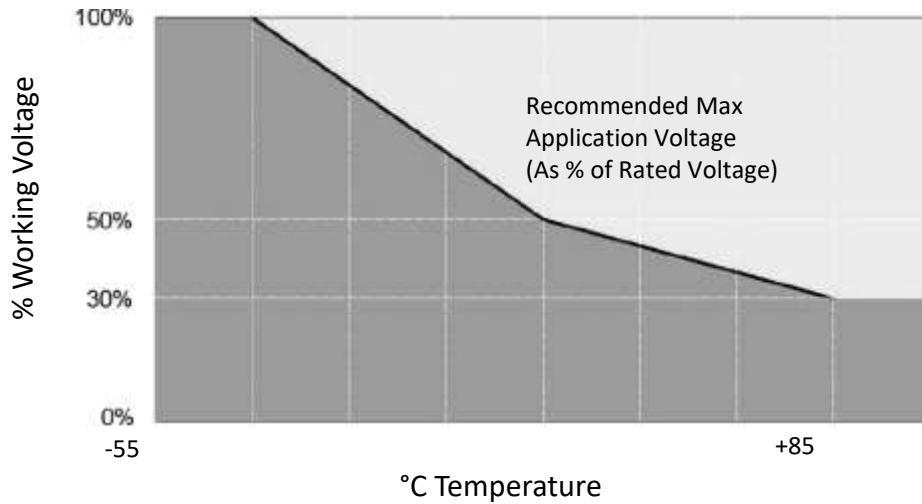

Condition	-55 °C ~ 85 °C
% Change in Working DC Voltage with Temperature	V _R
Recommended Max. Application @V _R ≤10V	50 of V _R
Recommended Max. Application @V _R ≥16V	30% of V _R

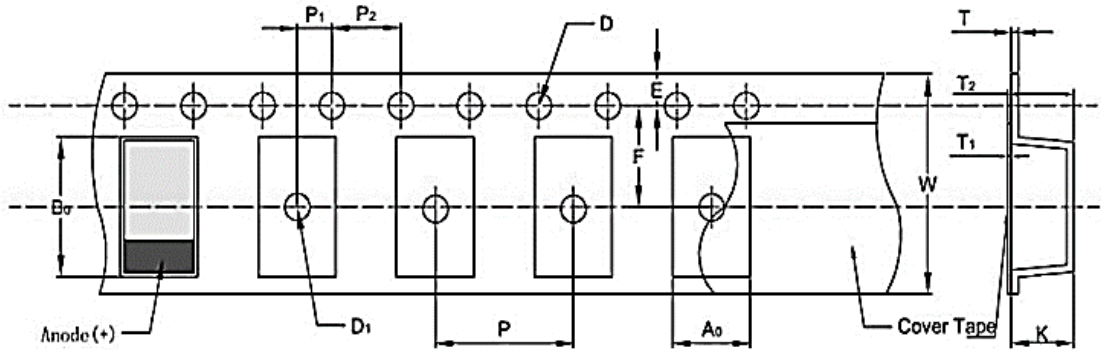
SMD TANTALUM CAPACITORS CA45L SERIES CASE B
TAPE DIMENSION (Unit: mm) Tolerance ± 0.2 mm over 10 sprocket hole spaces

Case Size Code	Dimension										
	A0	B0	K	W	E	F	P	P1	P2	D	D1
	± 0.1	± 0.1	± 0.1	± 0.3	± 0.1	± 0.05	± 0.1	± 0.05	± 0.1	$+0.2$	$+0.25$
A	1.88	3.53	1.85	8	1.75	3.5	4	4	2	1.55	1.0
B	3.07	3.8	2.22	8	1.75	3.5	4	4	2	1.55	1.1
C	3.6	6.4	2.85	12	1.75	5.5	4	8	2	1.55	1.6
D	4.6	7.6	3.1	12	1.75	5.5	4	8	2	1.55	1.55
E	4.6	7.6	4.4	12	1.75	5.5	4	8	2	1.55	1.55
F	6.5	7.6	2.2	12	1.75	5.5	4	8	2	1.55	1.5
H	4.6	7.6	2.16	12	1.75	5.5	4	8	2	1.55	1.55
H1	4.6	7.6	2.16	12	1.75	5.5	4	8	2	1.55	1.55
L	4.6	7.6	2.16	12	1.75	5.5	4	8	2	1.55	1.55
V	6.4	7.6	4.4	12	1.75	5.5	4	8	2	1.55	1.55
W	6.4	7.6	4.4	12	1.75	5.5	4	8	2	1.55	1.55
Y	4.6	7.6	3.1	12	1.75	5.5	4	8	2	1.55	1.55

SMD TANTALUM CAPACITORS CA45L SERIES CASE B

REEL DIMENSION (Unit: mm)

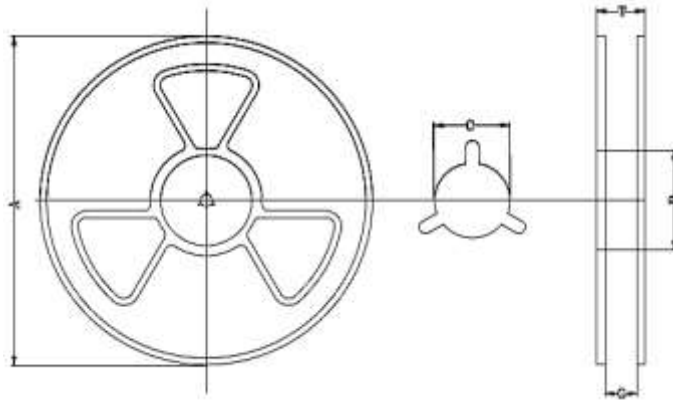

Reel Size	Tape Wide	Dimension				
		A	B	C	W	T
7" (180 mm)	8	178±2.0	50 Min.	13±0.5	8.4+1.5/-0	1.5±0.5
7" (180 mm)	12	178±2.0	50 Min.	13±0.5	12.4+1.5/0	1.5±0.5
7" (180 mm)	16	178±2.0	50 Min.	13±0.5	16.4+1.5/-1	1.5±0.5

QTY PER REEL (Unit: pcs)

Case Size Code	A	B	C	D	E	F	H	H1	L	V	W	Y
Qty.	2000	2000	500	500	500	500	1000	1000	1000	400	400	500

SMD TANTALUM CAPACITORS CA45L SERIES CASE B

IMPORTANT NOTES AND DISCLAIMER

1. **ROHS COMPLIANCE:** The levels of RoHS restricted materials in this product are below the maximum concentration values (also referred to as the threshold limits) permitted for such substances, or are used in an exempted application, in accordance with EU RoHS Directive (EU) 2015/863 EC (RoHS3). RoHS Test Report for this product can be obtained at Download Center.
2. **REACH COMPLIANCE:** REACH substances of high concern (SVHCs) information is available for this product. Since the European Chemical Agency (ECHA) has published notice of their intent to frequently revise the SVHC listing for the foreseeable future, REACH Test Report for this product can be obtained at Download Center.
3. All Product parametric performance is indicated in the Electrical Characteristics for the listed herein test conditions, unless otherwise noted. Product performance may not be indicated by the Electrical Characteristics if operated under different conditions.
4. NextGen Component, Inc (*NextGen*) reserves the right to make changes to this document and its products and specifications at any time without notice. Customers should obtain and confirm the latest product information and specifications before final design, purchase or use.
5. *NextGen* makes no warranty, representation or guarantee regarding the suitability of its products for any particular purpose, not does *NextGen* assume any liability for application assistance or customer product design.
6. *NextGen* does not warrant or accept any liability with products which are purchased or used for any unintended or unauthorized application. No license is granted by implication or otherwise under any intellectual property rights of NextGen.
7. *NextGen* products are not authorized for use as critical components in life support devices or systems without express written approval by *NextGen*.
8. *NextGen* requires that customers first obtain an RMA (Returned Merchandise Authorization) number prior to returning any products. Returns must be made within 30 days of the date of invoice, be in the original packaging, unused and like-new condition. At the time of quoting or purchasing, a product may say that it is Non-Cancelable/ Non-Returnable (NCNR). These products are not returnable and not refundable.