

Coaxial

# Pulse Amplifier

ZPUL-30P+

50Ω Non-Inverting 0.0025 to 700 MHz

## The Big Deal

- Wideband, 2.5 kHz - 700 MHz
- High gain, 35 dB typ. with excellent flatness,  $\pm 0.6$  dB typ.
- Can handle wide pulses width (15 $\mu$ s typ.) with excellent rise/fall time (1.1 ns typ.)
- Delay time, 1.5 ns typ.
- Protected by US Patent, 6,943,629



CASE STYLE: S32

## Product Overview

Mini-Circuits ZPUL-30P+ utilizes high power LDMOS transistor output stage. Class A operation accept any kind of modulation. The frequency range is so wide (280,000:1) that the amplifier may handle long pulses, 15 $\mu$ sec typ. with very short rise and fall duration 1.1 nsec. typ. Of course it may work as a ordinary RF amplifier within its very wide frequency range.

## Key Features

Feature	Advantages
Current stabilization circuits.	The design utilizes a patented technology to set and maintain the constant current consumption.
Rugged Design	Extreme load mismatch such as open/short at output are tolerated without damaging the amplifier.
Range of Protections	Reverse polarity protection.

### Notes

- A. Performance and quality attributes and conditions not expressly stated in this specification document are intended to be excluded and do not form a part of this specification document.  
B. Electrical specifications and performance data contained in this specification document are based on Mini-Circuit's applicable established test performance criteria and measurement instructions.  
C. The parts covered by this specification document are subject to Mini-Circuits standard limited warranty and terms and conditions (collectively, "Standard Terms"); Purchasers of this part are entitled to the rights and benefits contained therein. For a full statement of the Standard Terms and the exclusive rights and remedies thereunder, please visit Mini-Circuits' website at [www.minicircuits.com/MCLStore/terms.jsp](http://www.minicircuits.com/MCLStore/terms.jsp)



# Coaxial Pulse Amplifier

## ZPUL-30P+

50Ω Non-Inverting 0.0025 to 700 MHz

### Features

- wide bandwidth 2.5 kHz to 700 MHz, useable to 1000 MHz
- excellent flatness,  $\pm 0.6$  dB typ.
- can handle wide pulse width & (15 $\mu$ s typ.) with excellent rise/fall time (1.1 ns typ.)
- delay time, 1.5 ns typ.
- protected by US Patent, 6,943,629

### Applications

- computers
- digital communication
- medical test set-ups



CASE STYLE: S32  
Connectors Model  
BNC ZPUL-30P+

### Pulse Amplifier Electrical Specifications

Parameter	ZPUL-30P+			Units
	Min.	Typ.	Max.	
Frequency Range	0.0025		700	MHz
Gain	29	35	—	dB
Gain Flatness	—	—	$\pm 1.0$	dB
Output Power at 1dB compression	+22***	—	—	dBm
Output Third Order Intercept Point (OIP3)	—	+34	—	dBm
Noise Figure**	—	7.7	—	dB
Rise/Fall Time	—	—	1.5	ns
Pulse Width*	6	15	—	$\mu$ s
Input VSWR <sup>1</sup>	—	2.0	—	:1
Output VSWR	—	2.0	—	:1
DC Supply Voltage	—	24	—	V
Supply Current	—	—	400	mA

\* Pulse width for less than 10% droop.

\*\* Noise Figure tested above 10 MHz.

Open load is not recommended, potentially can cause damage.

With no load derate max input power by 20 dB

\*\*\* For 500-700 MHz, +20.5 dBm

### Maximum Ratings

Operating Temperature -20°C to 65°C

Storage Temperature -55°C to 100°C

DC Voltage +24.5V Max.

Input Power (no damage) +10 dBm

Permanent damage may occur if any of these limits are exceeded.

### Notes

A. Performance and quality attributes and conditions not expressly stated in this specification document are intended to be excluded and do not form a part of this specification document.

B. Electrical specifications and performance data contained in this specification document are based on Mini-Circuit's applicable established test performance criteria and measurement instructions.

C. The parts covered by this specification document are subject to Mini-Circuits standard limited warranty and terms and conditions (collectively, "Standard Terms"); Purchasers of this part are entitled to the rights and benefits contained therein. For a full statement of the Standard Terms and the exclusive rights and remedies thereunder, please visit Mini-Circuits' website at [www.minicircuits.com/MCLStore/terms.jsp](http://www.minicircuits.com/MCLStore/terms.jsp)



[www.minicircuits.com](http://www.minicircuits.com) P.O. Box 350166, Brooklyn, NY 11235-0003 (718) 934-4500 sales@minicircuits.com

REV. OR  
M173321  
ZPUL-30P+  
190319  
Page 2 of 4

## Outline Drawing

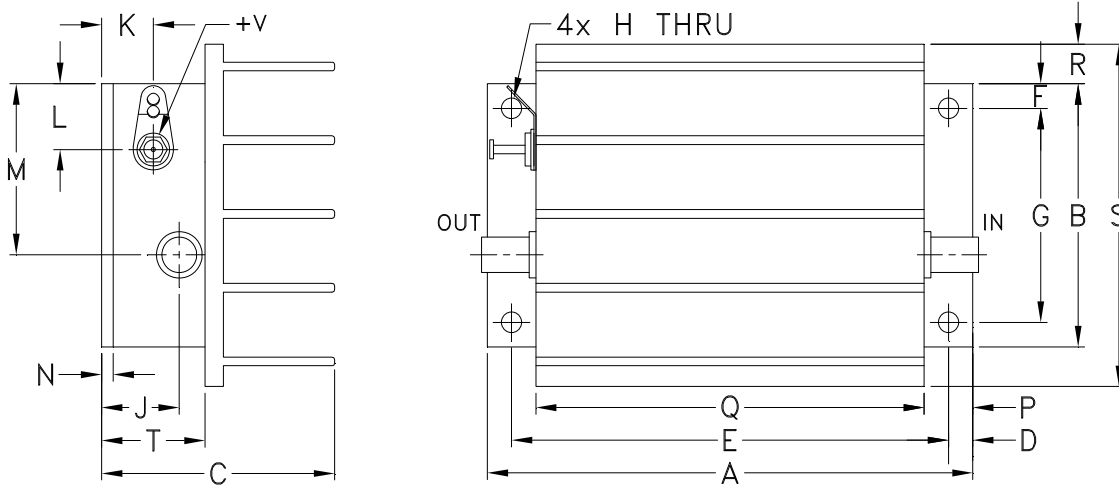

## Outline Dimensions (inch)

A	B	C	D	E	F	G	H	J	K	L	M	N	P	Q	R	S	T	wt
3.75	2.00	1.80	.19	3.375	.19	1.625	.144	.50	.40	.50	1.30	.10	.38	3.00	.30	2.60	.80	grams
95.25	50.80	45.72	4.83	85.73	4.83	41.28	3.66	12.70	10.16	12.70	33.02	2.54	9.65	76.20	7.62	66.04	20.32	220.0

## typical amplifier response to a pulse input

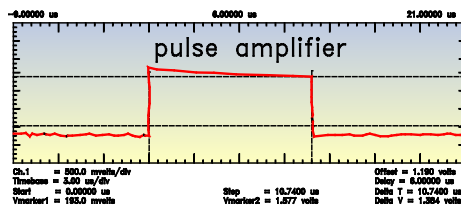
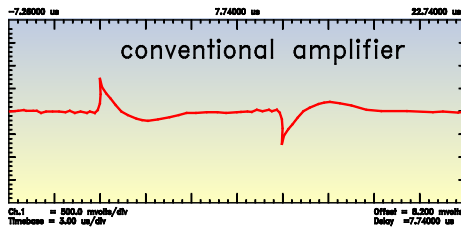

## Notes

- Performance and quality attributes and conditions not expressly stated in this specification document are intended to be excluded and do not form a part of this specification document.
- Electrical specifications and performance data contained in this specification document are based on Mini-Circuit's applicable established test performance criteria and measurement instructions.
- The parts covered by this specification document are subject to Mini-Circuits standard limited warranty and terms and conditions (collectively, "Standard Terms"); Purchasers of this part are entitled to the rights and benefits contained therein. For a full statement of the Standard Terms and the exclusive rights and remedies thereunder, please visit Mini-Circuits' website at [www.minicircuits.com/MCLStore/terms.jsp](http://www.minicircuits.com/MCLStore/terms.jsp)

# Typical Performance Data/Curves

# ZPUL-30P+

FREQUENCY (MHz)	GAIN (dB)	DIRECTIVITY (dB)	VSWR (:1)		NOISE FIGURE (dB)	POUT at 1 dB COMPR. (dBm)	OUTPUT IP3 (dBm)
	24V	24V	IN	OUT	24V		24V
0.0025	35.64	31.23	1.33	1.23	--	--	--
0.010	35.11	25.86	1.06	1.06	--	--	--
0.050	34.95	28.03	1.02	1.05	--	--	--
0.100	35.03	22.39	1.02	1.09	--	--	--
0.200	35.15	28.86	1.02	1.13	--	--	--
1	35.17	27.99	1.02	1.15	--	--	--
2	35.14	27.59	1.03	1.15	--	--	36.59
10	34.65	47.00	1.03	1.17	8.04	24.48	37.03
50	34.60	45.74	1.06	1.19	7.74	25.54	37.88
100	35.10	51.26	1.08	1.23	7.77	25.51	37.96
200	35.54	44.55	1.08	1.31	7.76	25.04	37.42
300	35.51	39.14	1.08	1.35	7.74	24.46	36.36
400	35.34	49.01	1.09	1.31	7.77	23.98	36.81
500	35.13	40.32	1.12	1.22	7.79	23.78	36.25
600	35.03	40.83	1.16	1.20	7.81	23.70	35.27
700	35.06	58.56	1.23	1.44	7.86	22.70	33.86

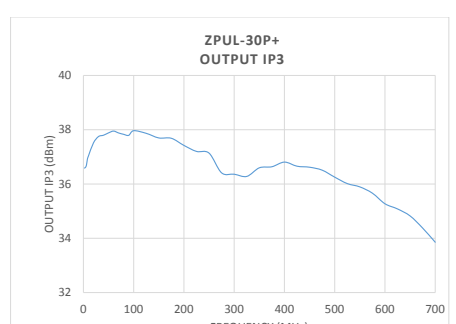
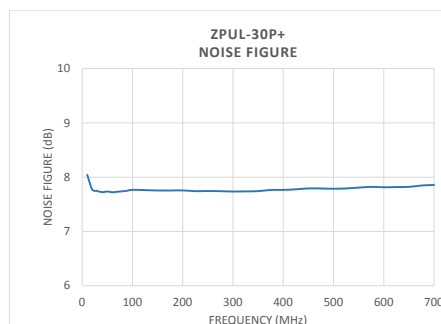
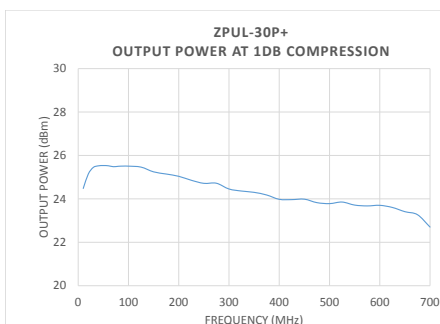
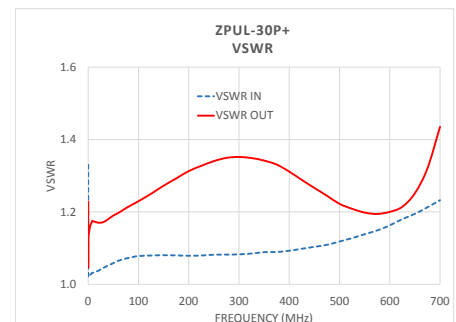
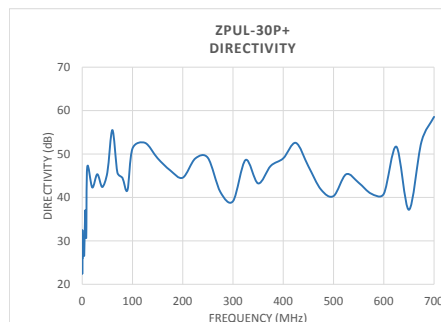
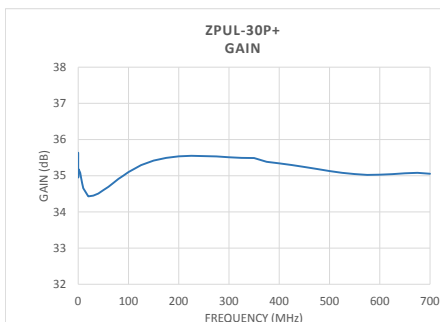

**Notes**

- A. Performance and quality attributes and conditions not expressly stated in this specification document are intended to be excluded and do not form a part of this specification document. Page 2 of 2
- B. Electrical specifications and performance data contained in this specification document are based on Mini-Circuit's applicable established test performance criteria and measurement instructions.
- C. The parts covered by this specification document are subject to Mini-Circuits standard limited warranty and terms and conditions (collectively, "Standard Terms"); Purchasers of this part are entitled to the rights and benefits contained therein. For a full statement of the Standard Terms and the exclusive rights and remedies thereunder, please visit Mini-Circuits' website at [www.minicircuits.com/MCLStore/terms.jsp](http://www.minicircuits.com/MCLStore/terms.jsp)

